



VOORLOPIG ONTWERP
DESA WARANDE LELYSTAD

CONCEPT



BDG Architecten Ingenieurs Almere
7421-V-02 25-05-2009
Opdrachtgever: Mateboer BV



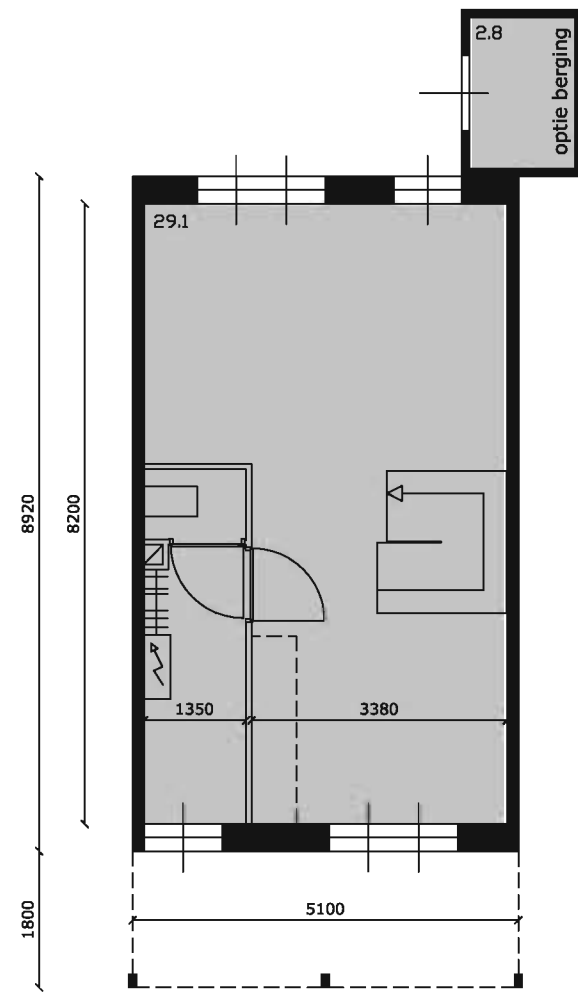

begane grond

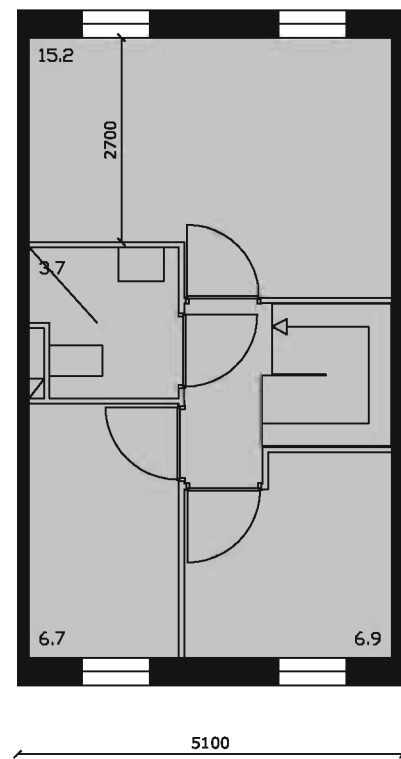

1e verdieping

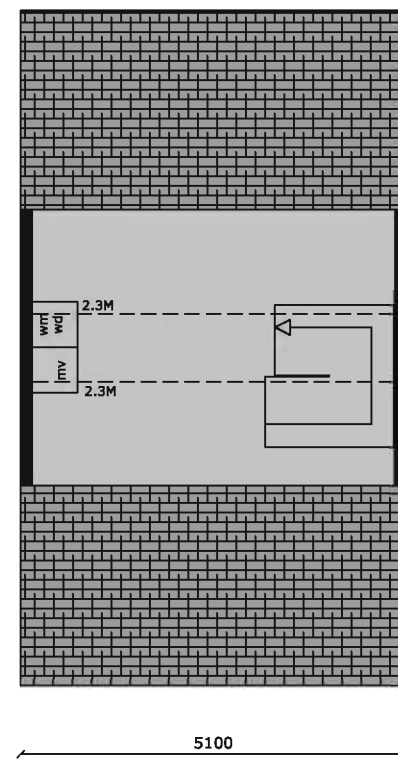

2e verdieping

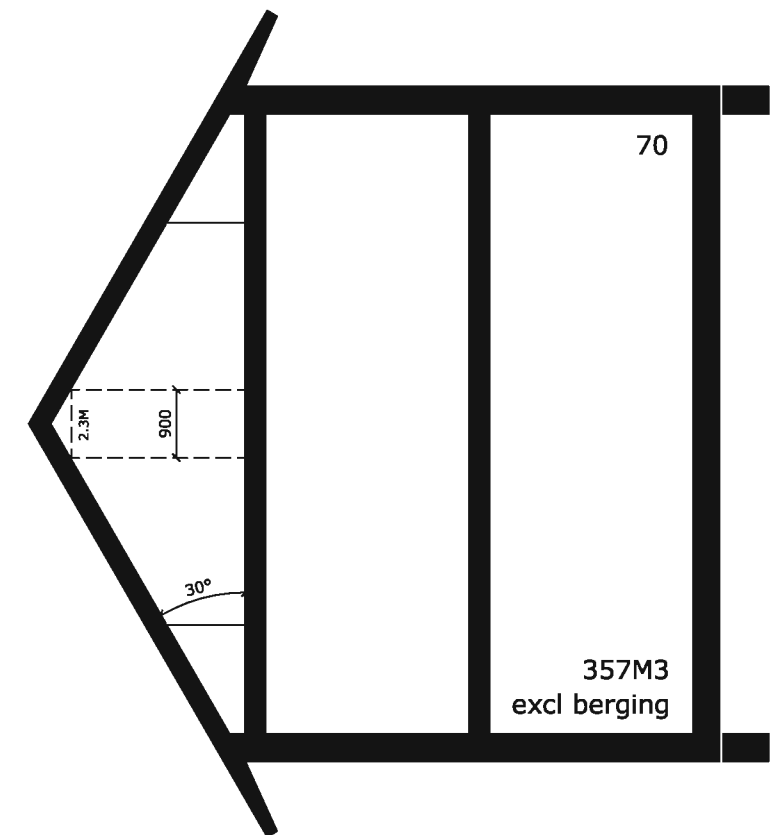



langsgevel entreezijde



zijgevel



langsgevel terraszijde



zijgevel



langsgevel entreezijde



zijgevel

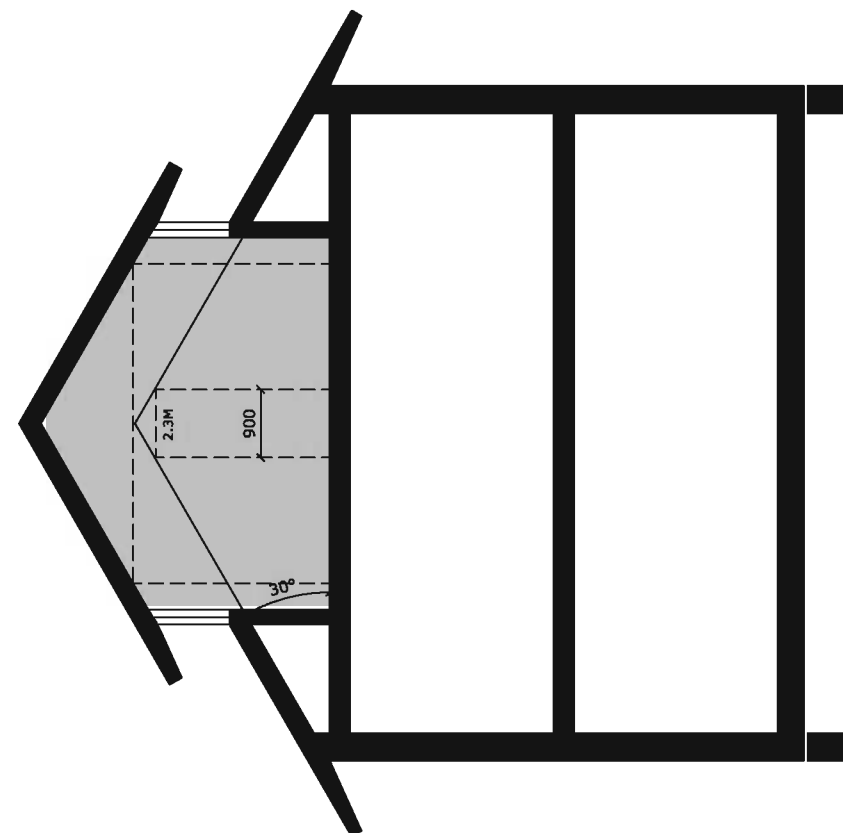
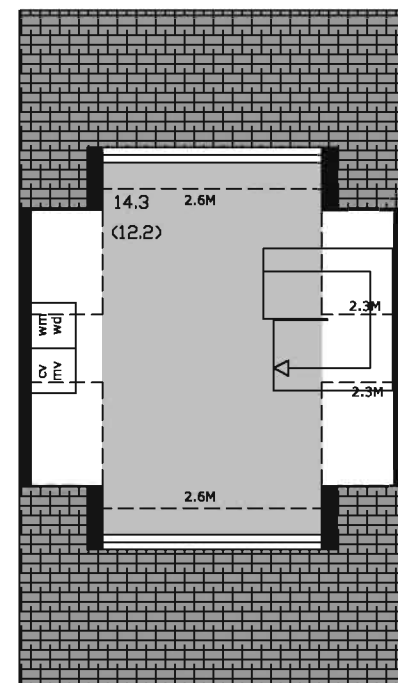

optie dakkapel
RIJWONING HUUR

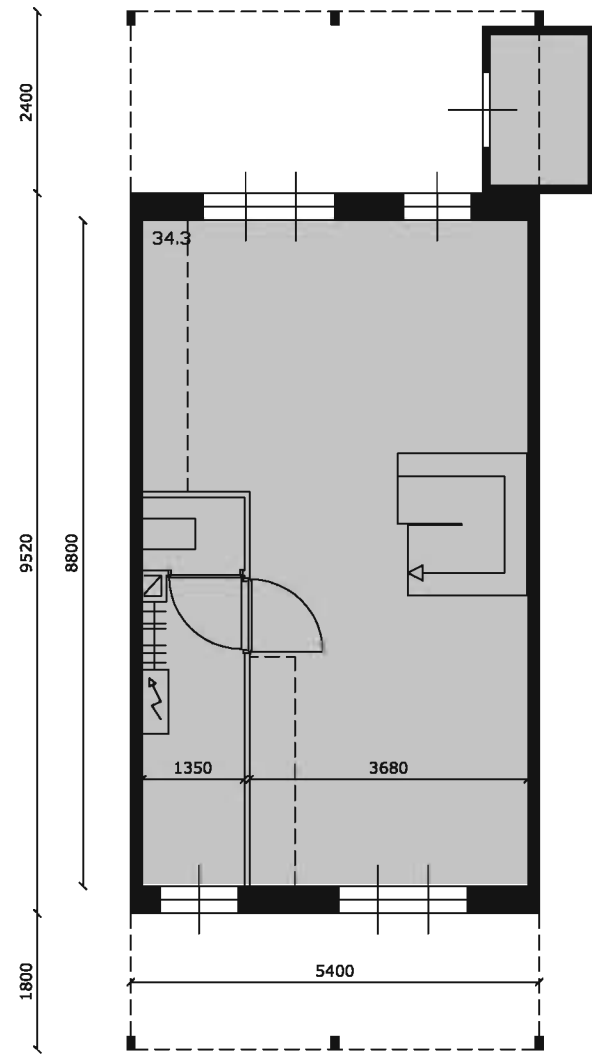

begane grond

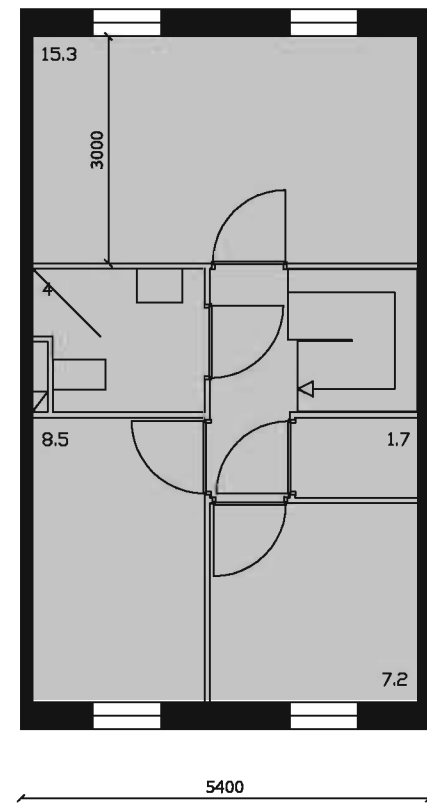

1e verdieping

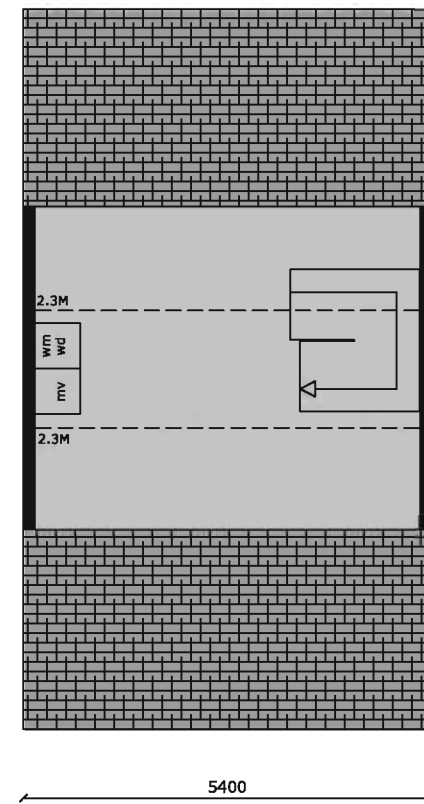

2e verdieping

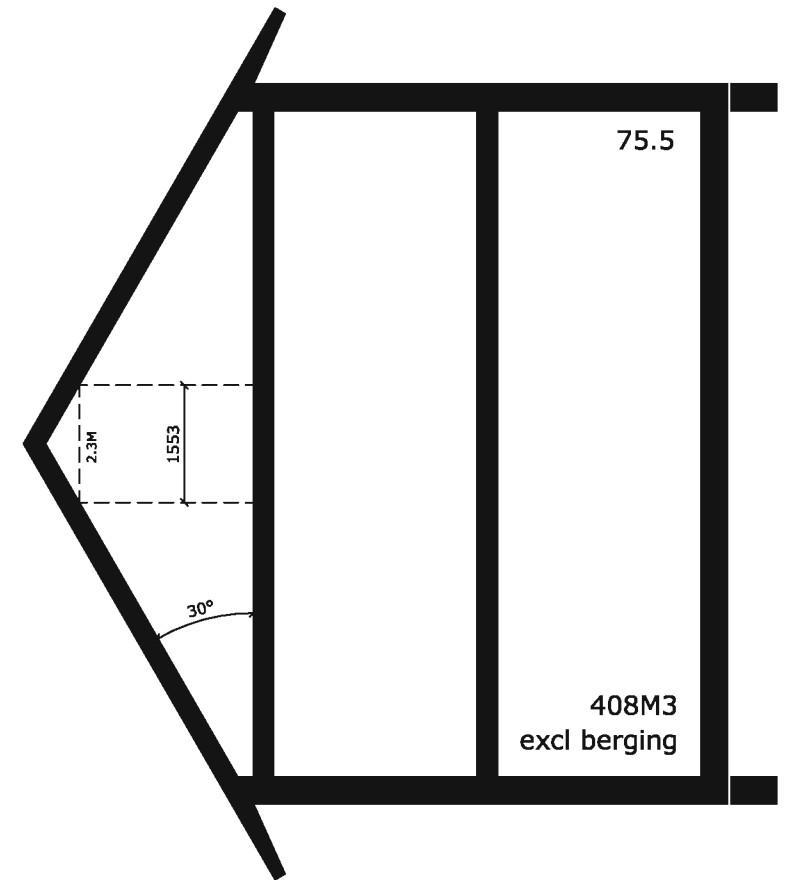



langsgevel entreezijde



zijgevel

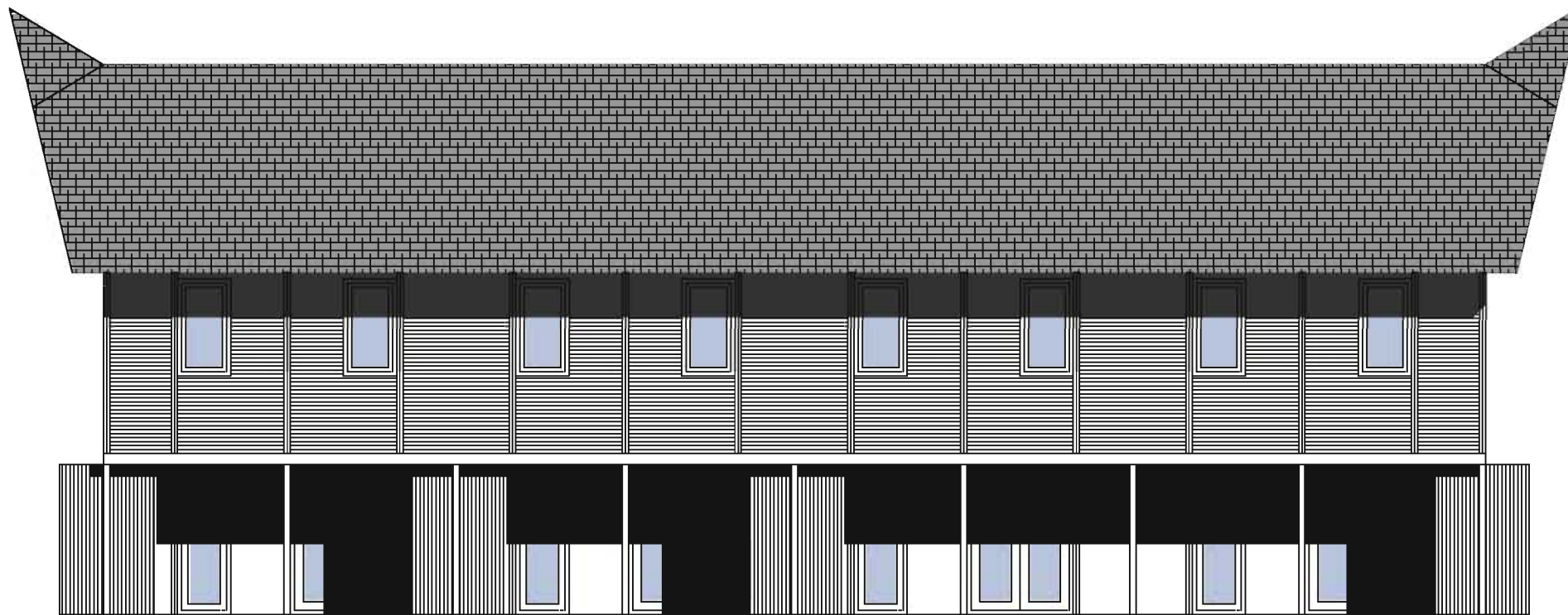

langsgevel terraszijde



zijgevel

RIJWONING KOOP



achtergevel

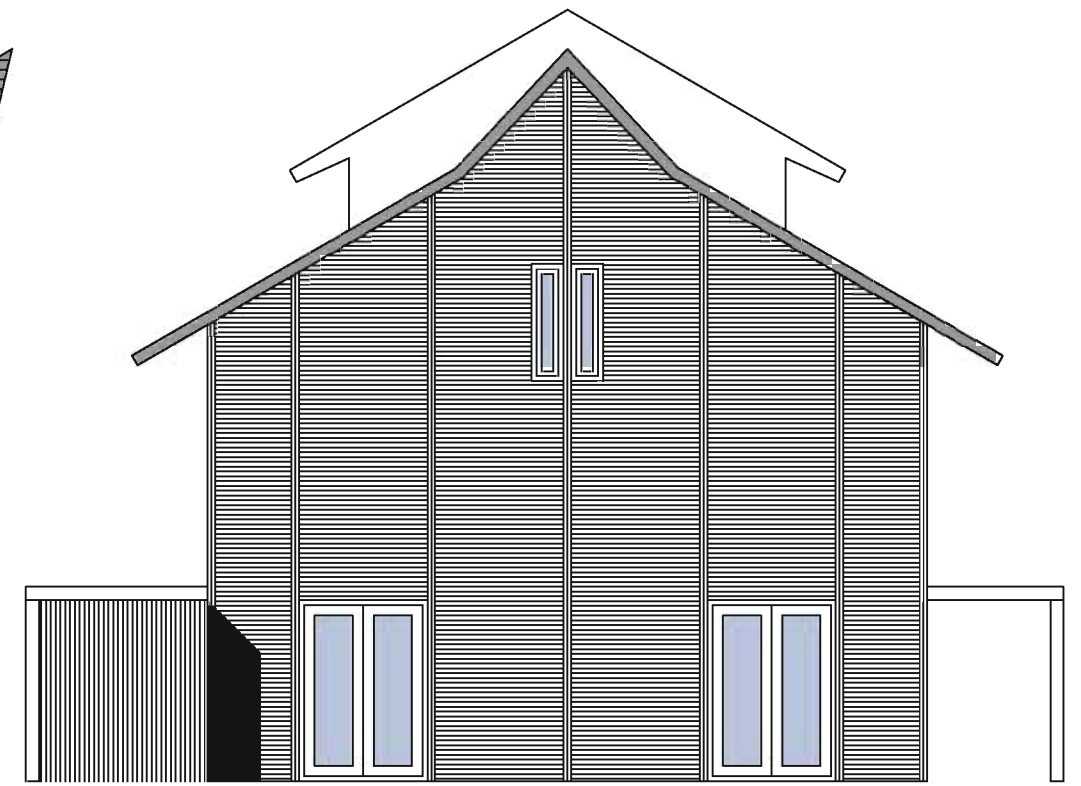

zijgevel

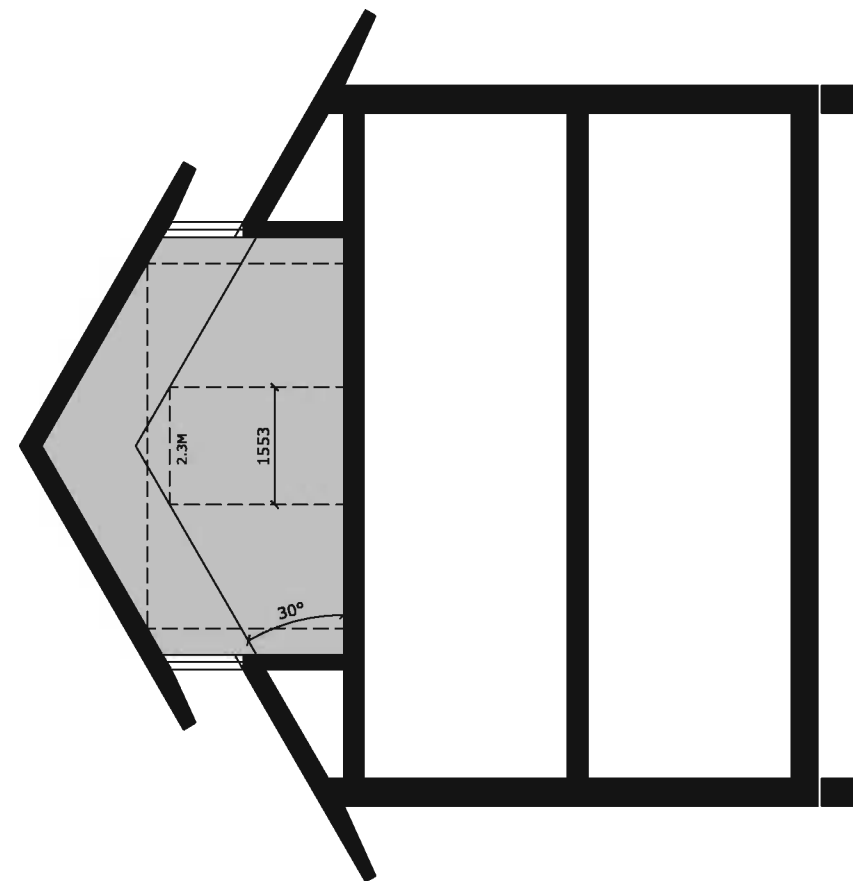
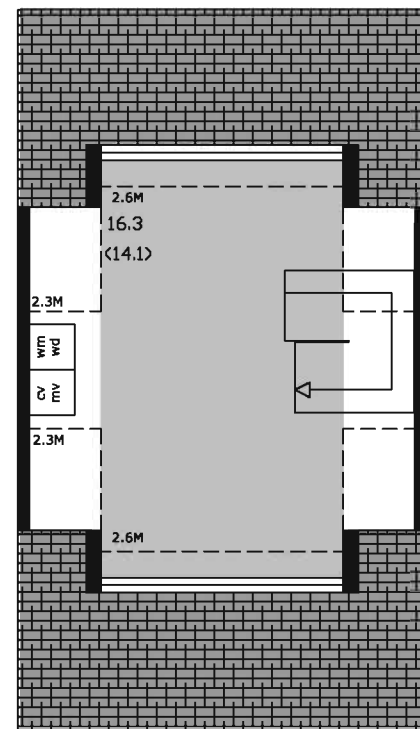

optie dakkapel
RIJWONING KOOP

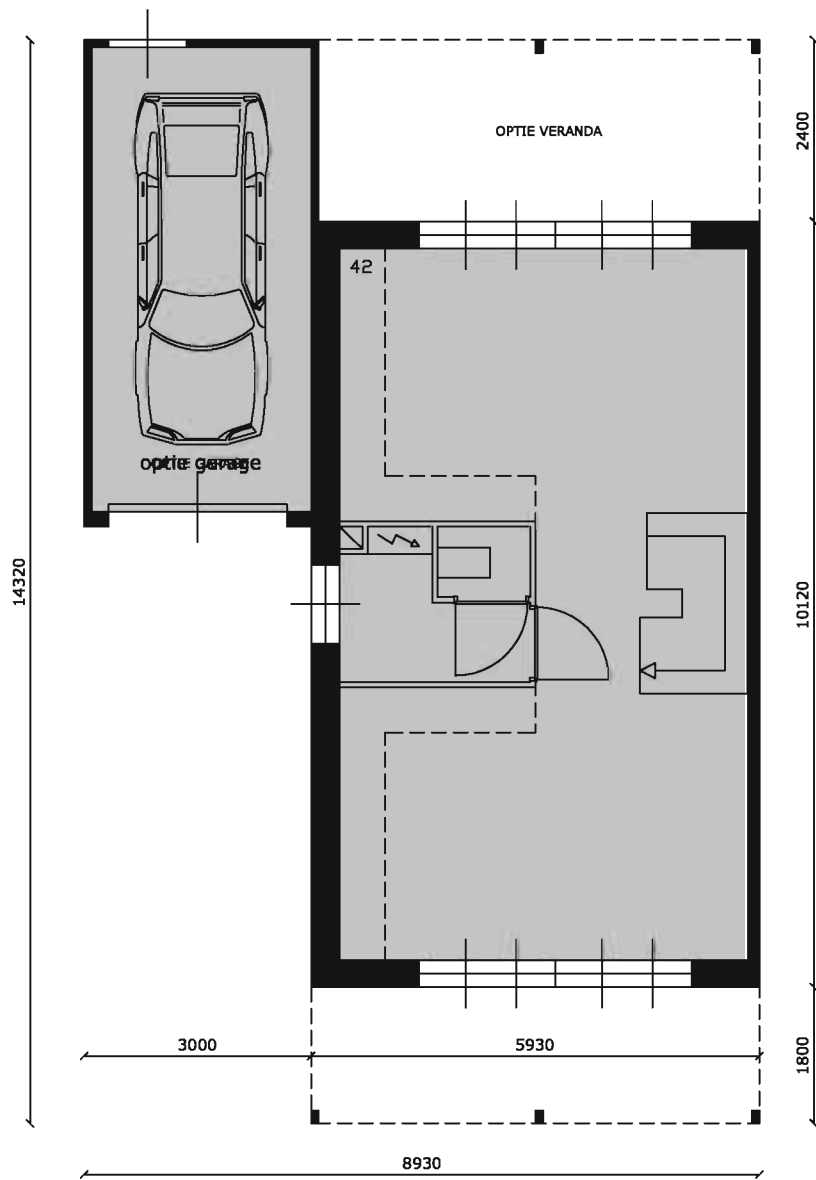

begane grond

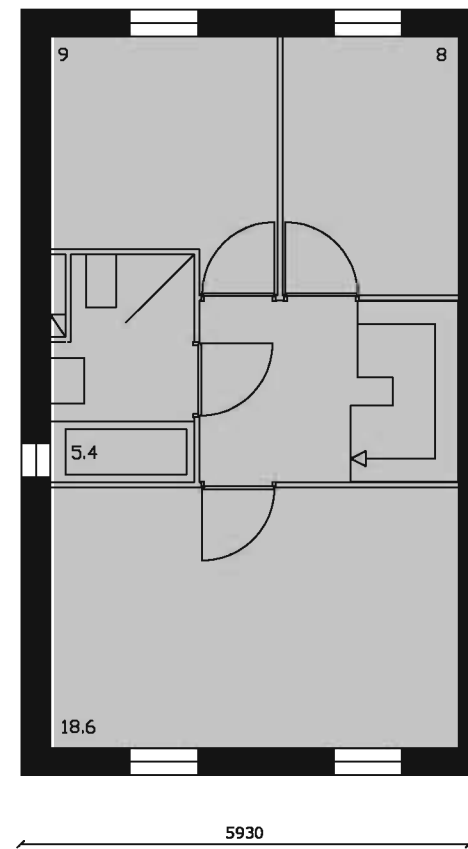

1e verdieping

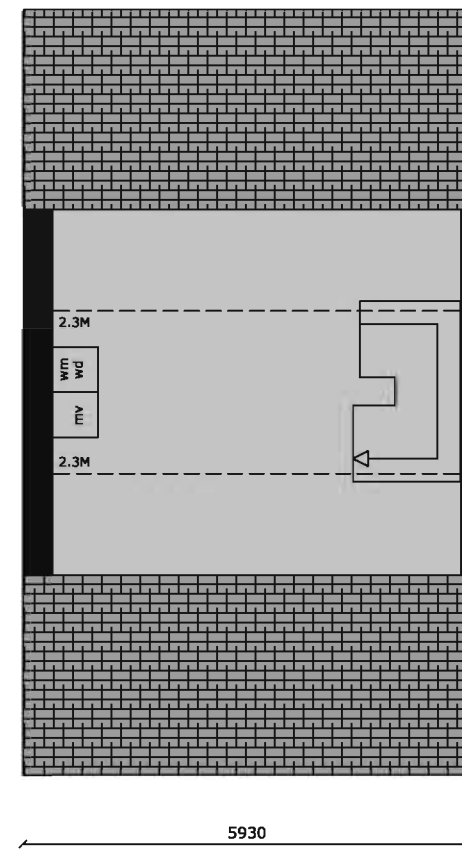

2e verdieping

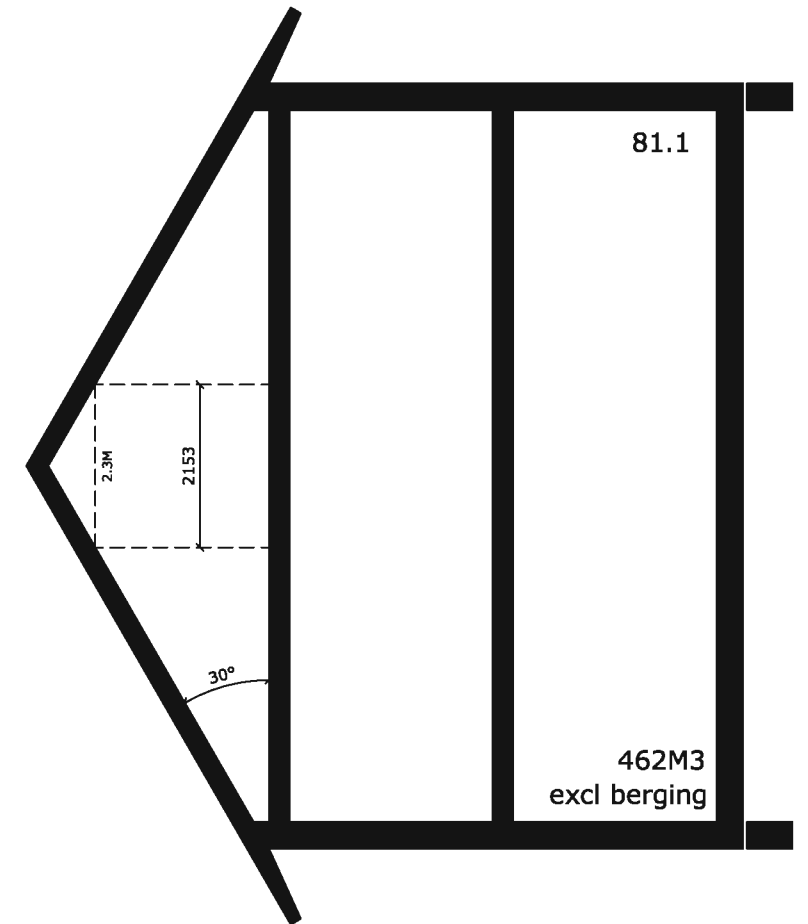



voorgevel



zijgevel



achtergevel



zijgevel

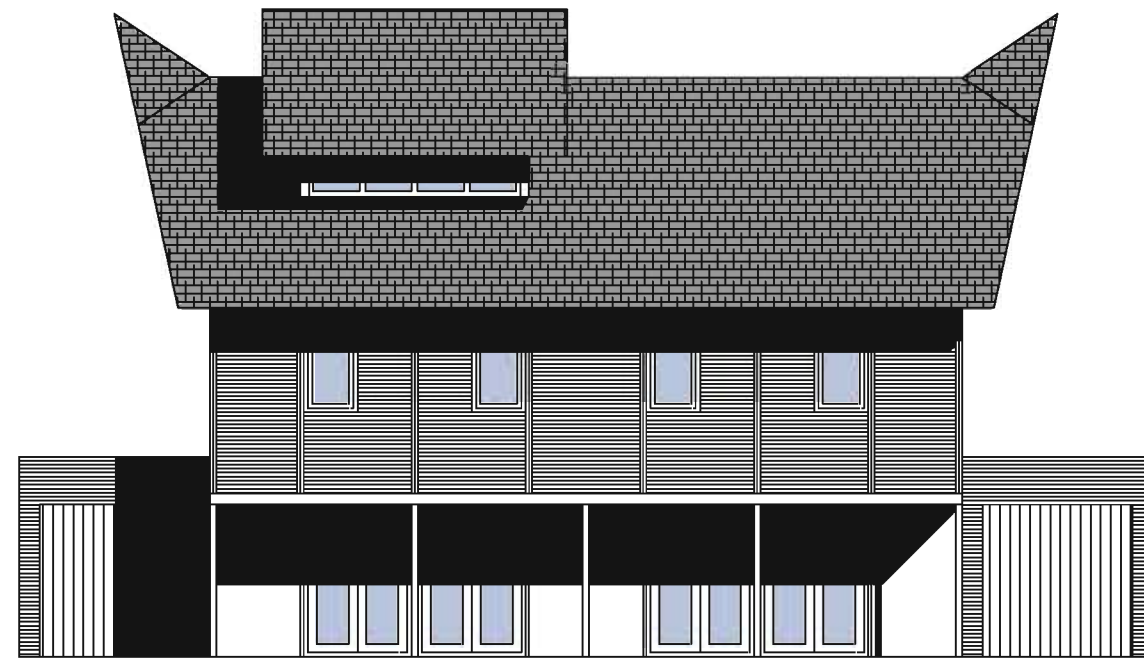

voorgevel

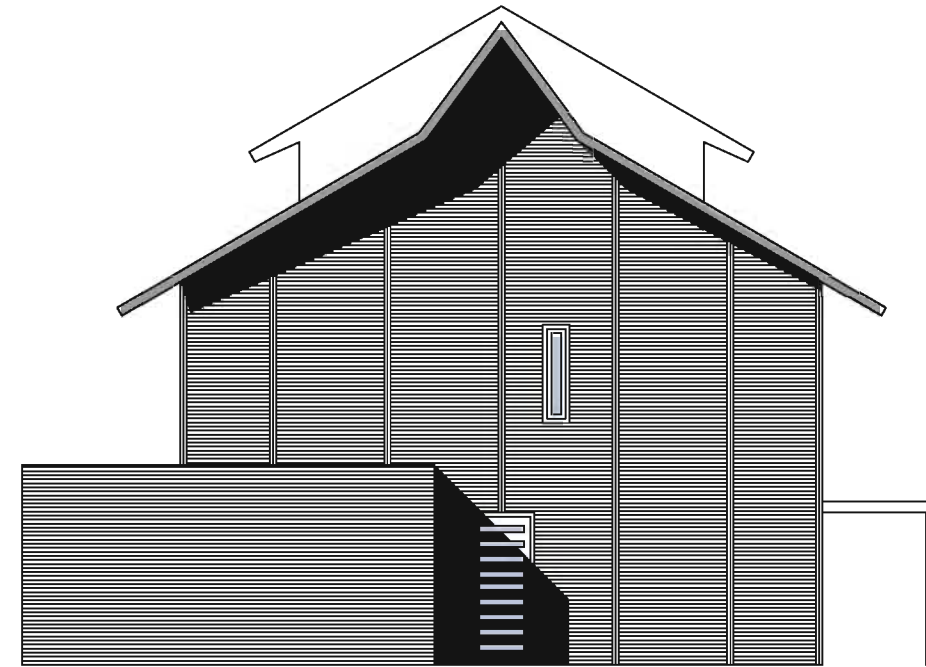

zijgevel

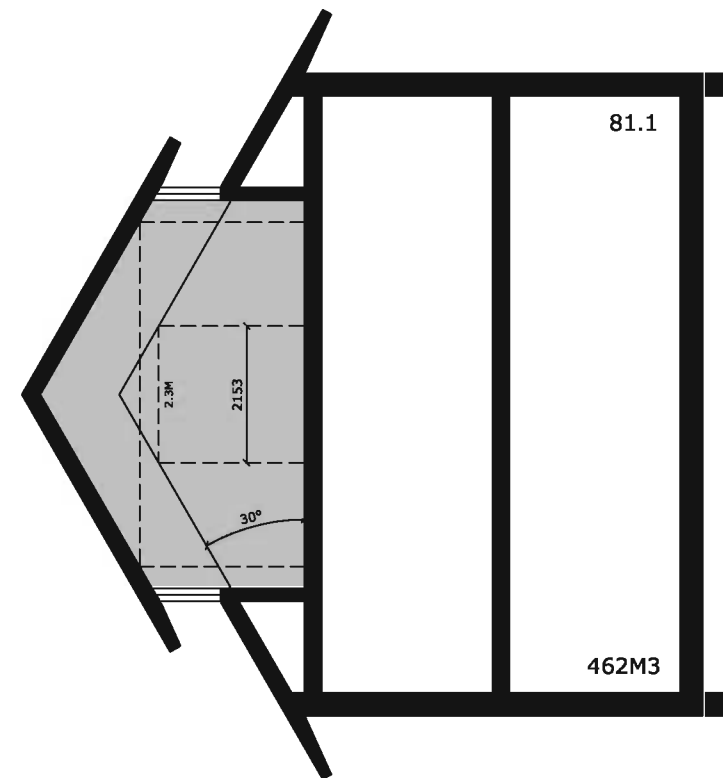
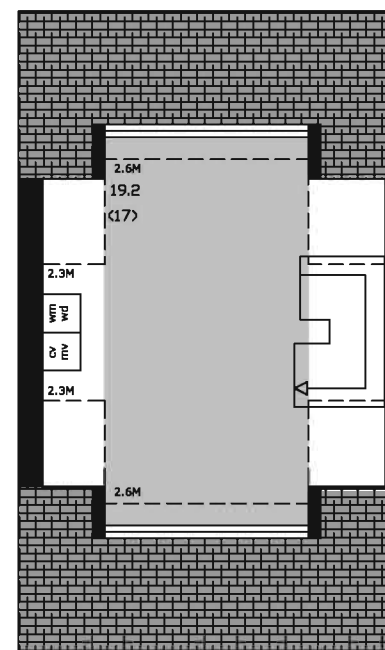

optie dakkapel
2^1 KAP WONING

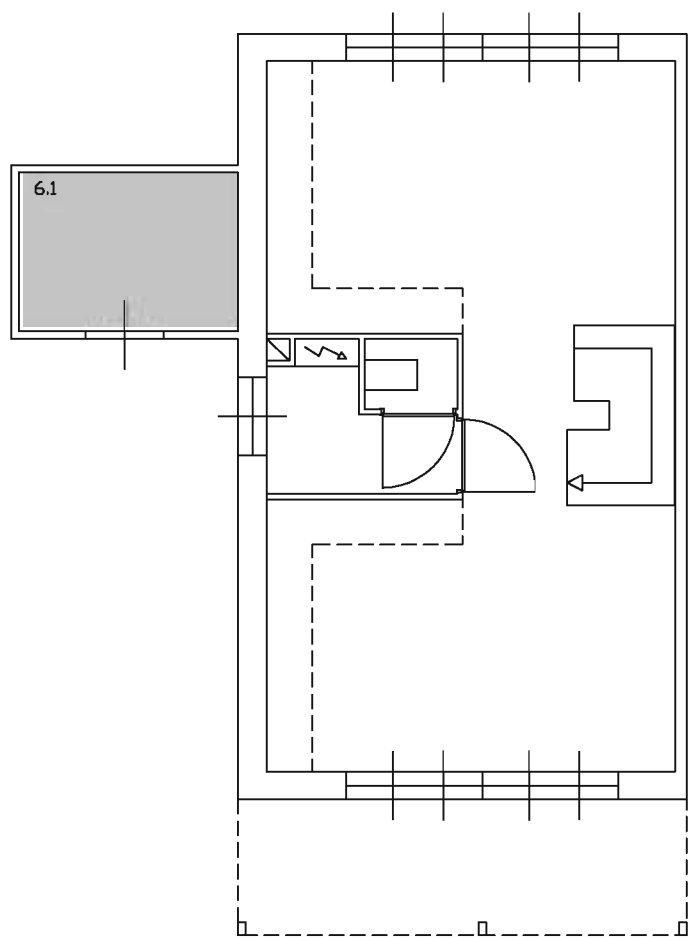

optie 1

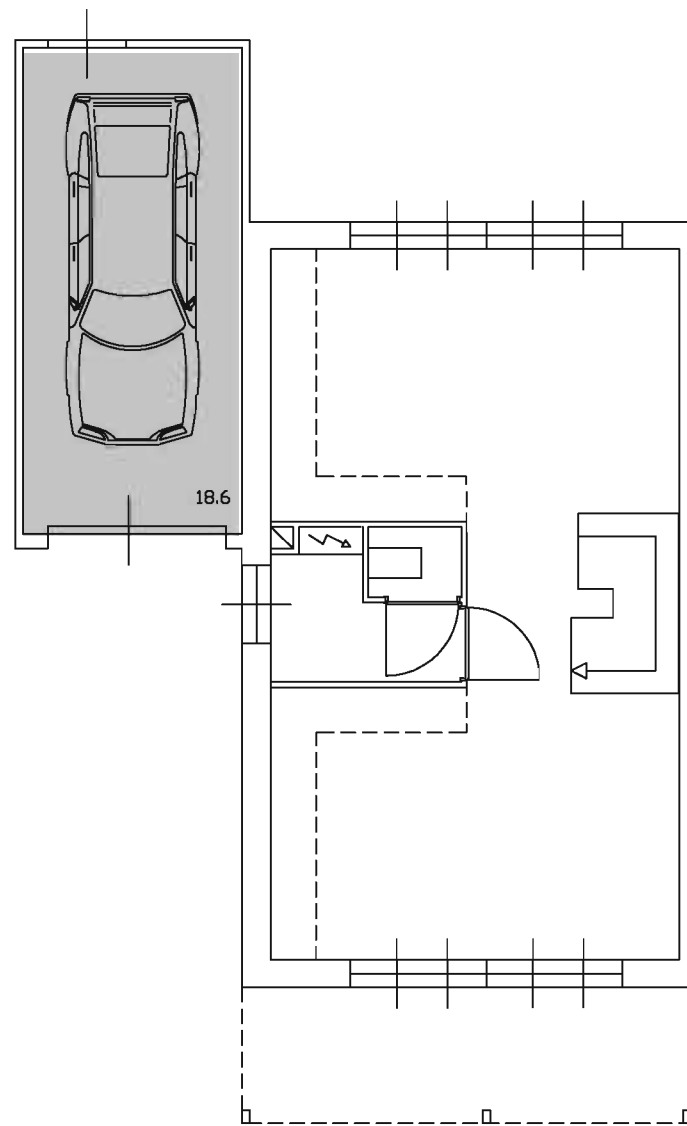

optie 2

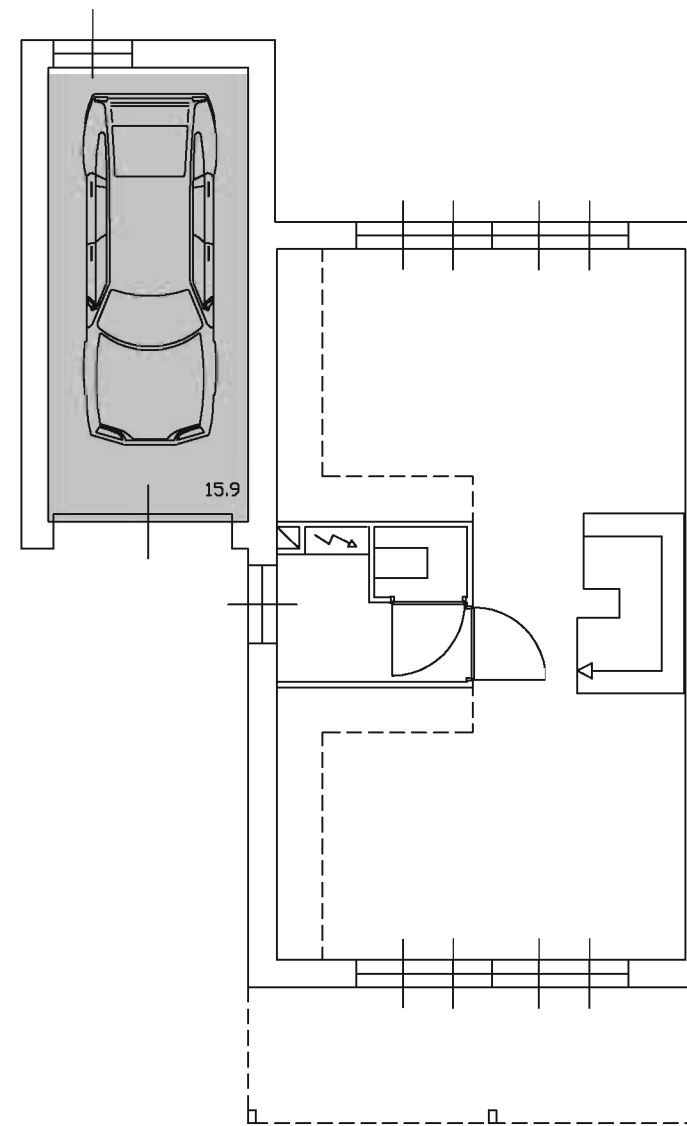

optie 3

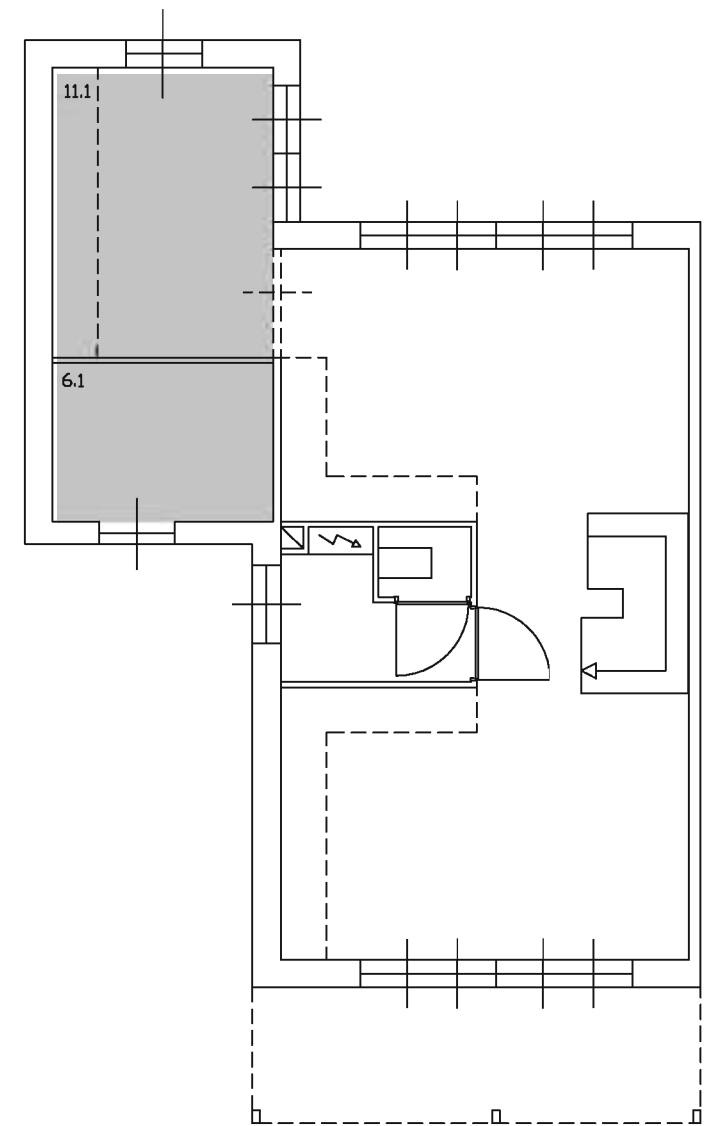

optie 4

opties
2[^]1 KAP WONING

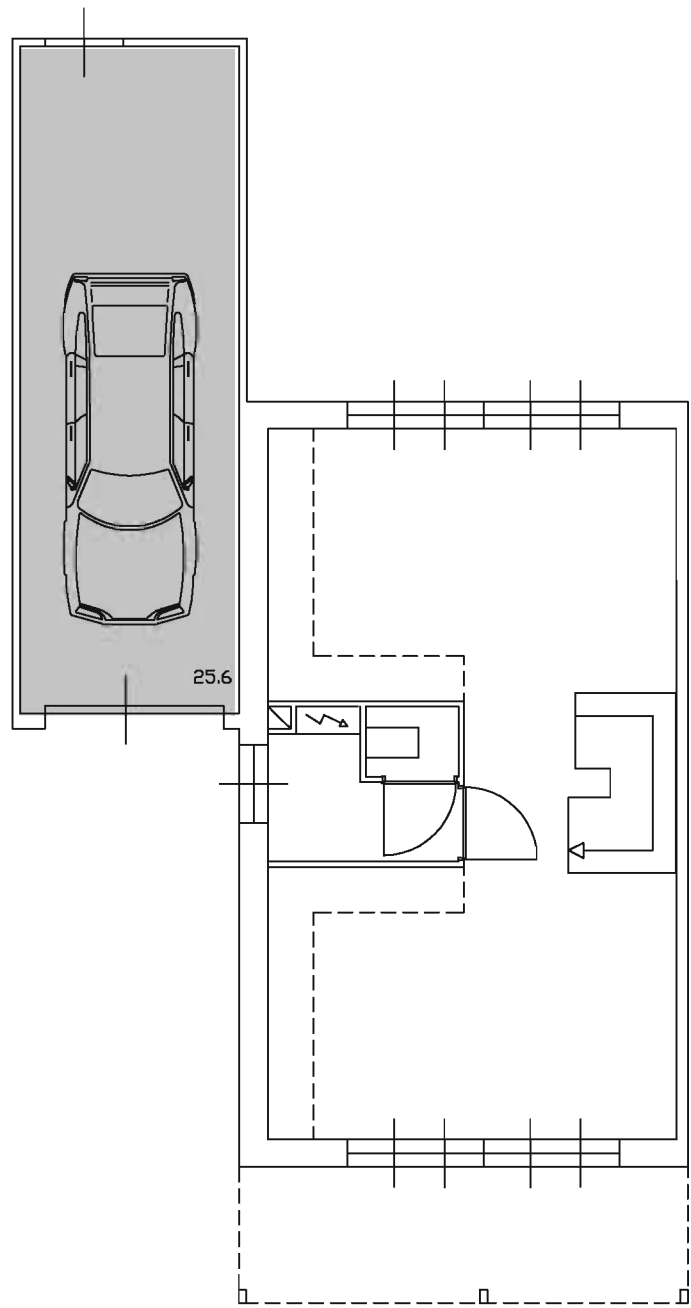

optie 5

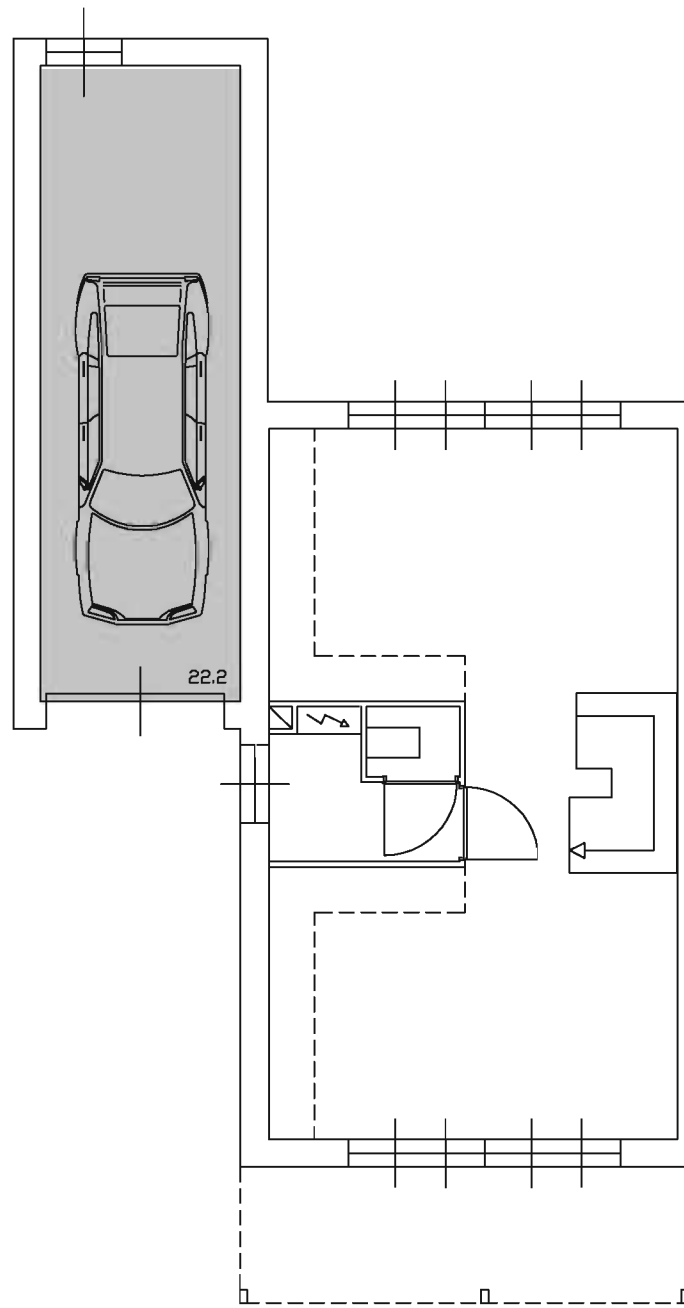

optie 6

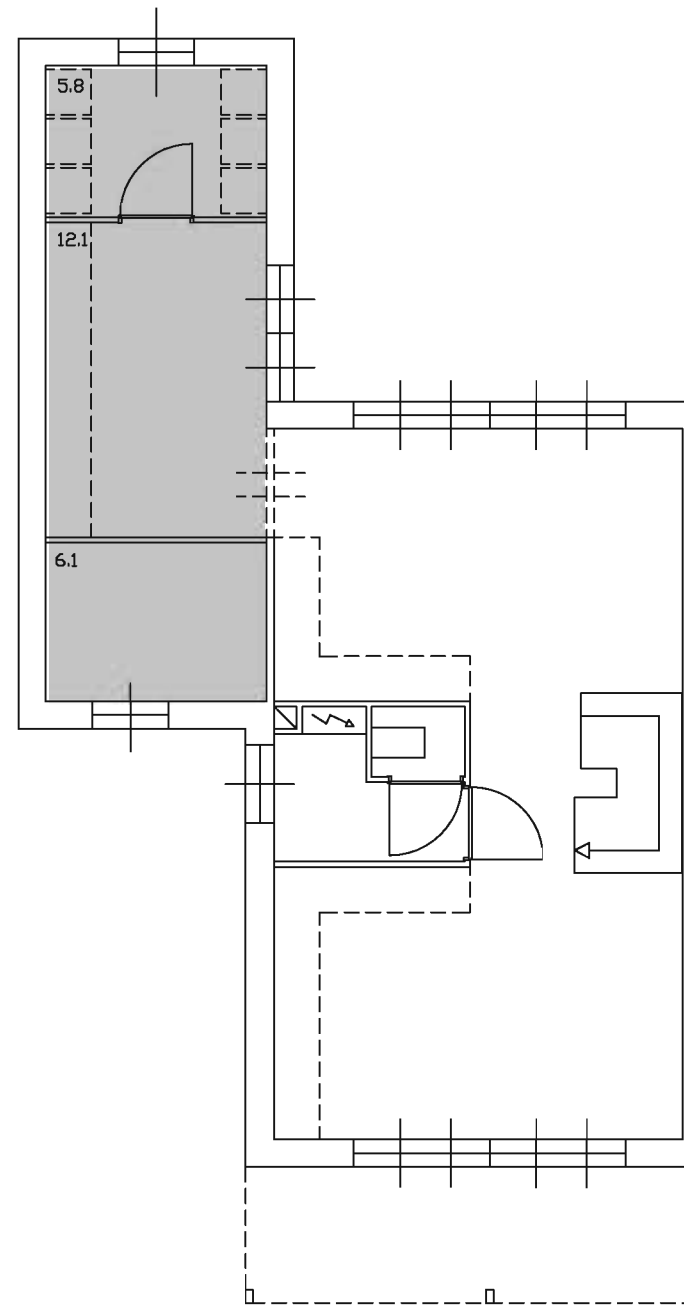

optie 7

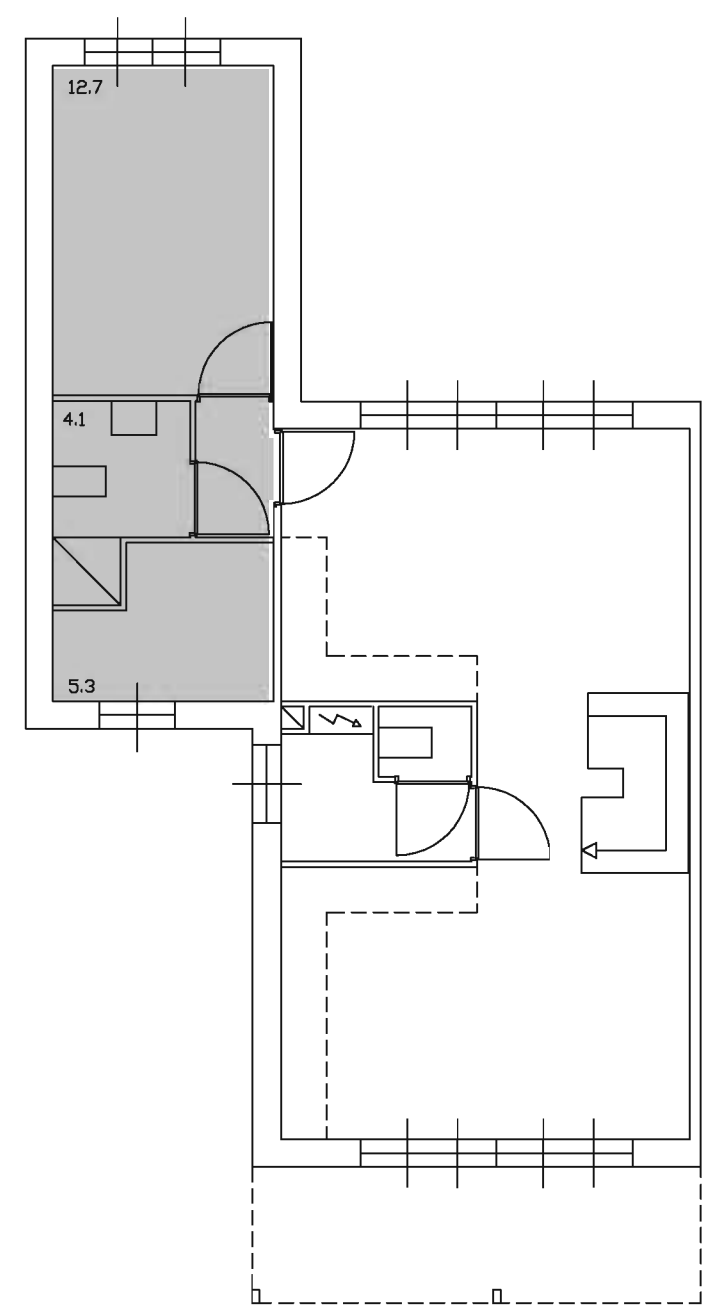

optie 8

opties
2^1 KAP WONING

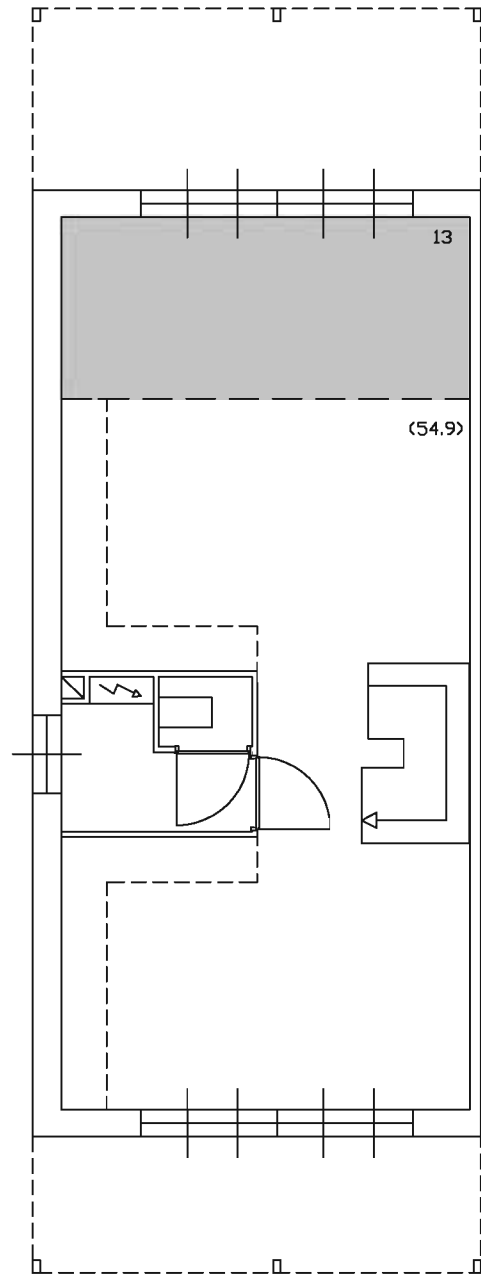

optie 9: uitbouw achterzijde
optie 10: veranda

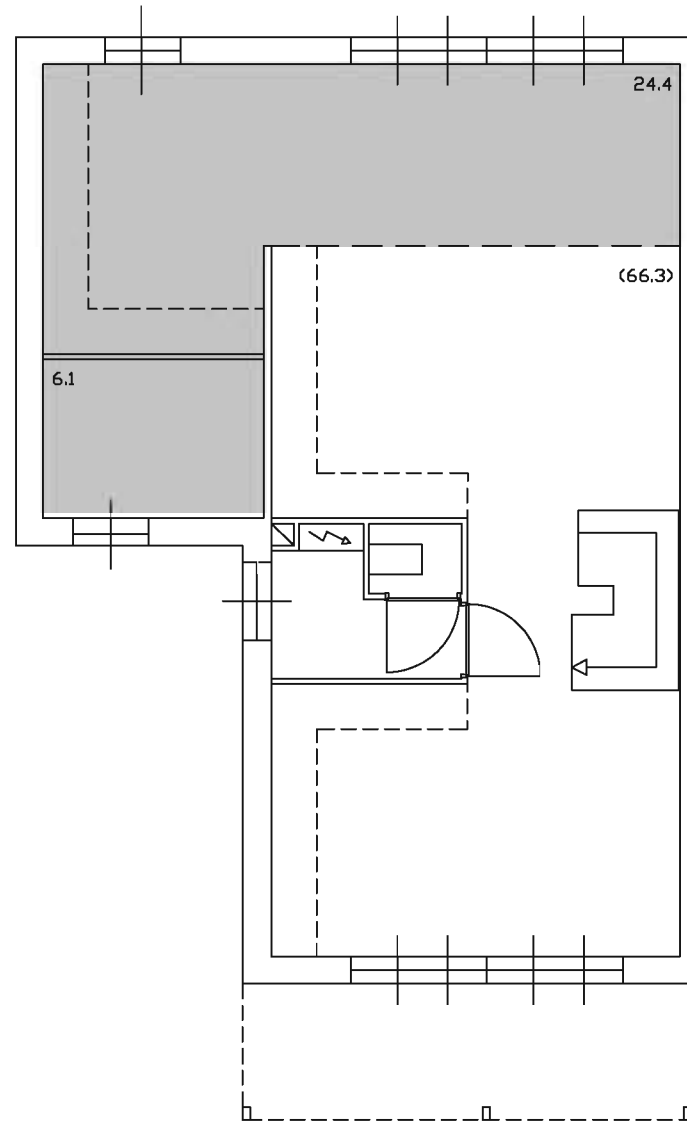

optie 11

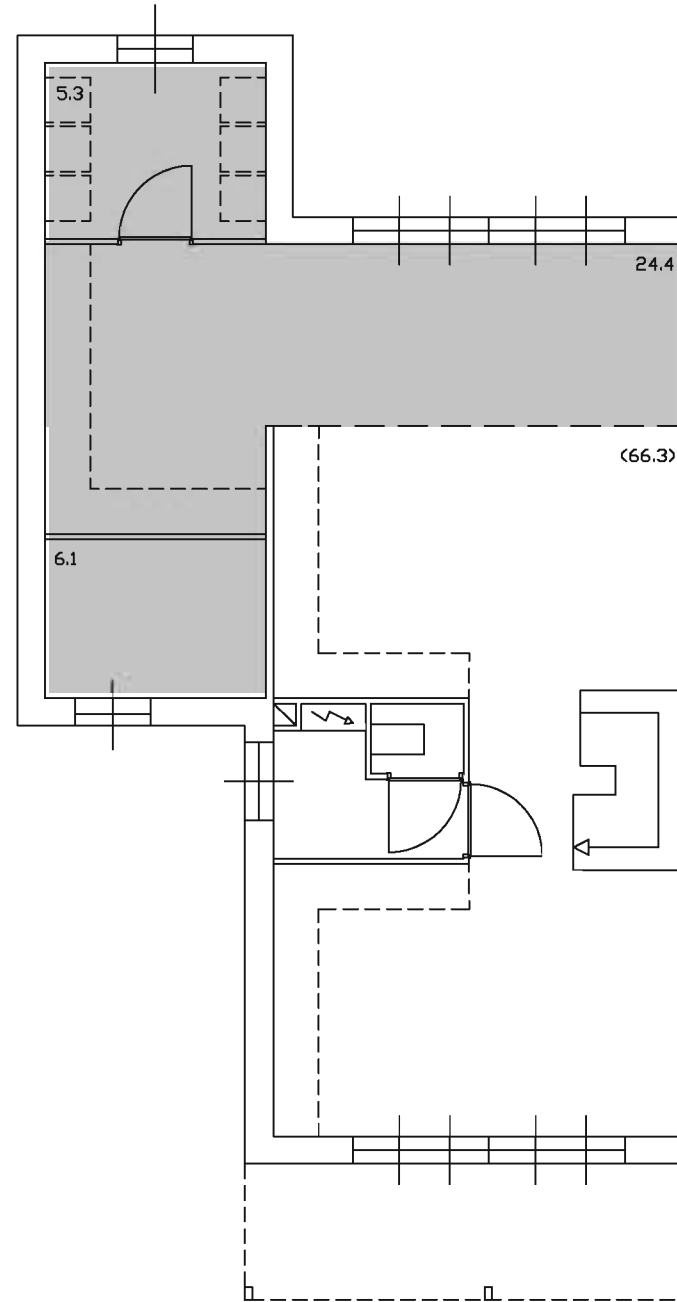

optie 12

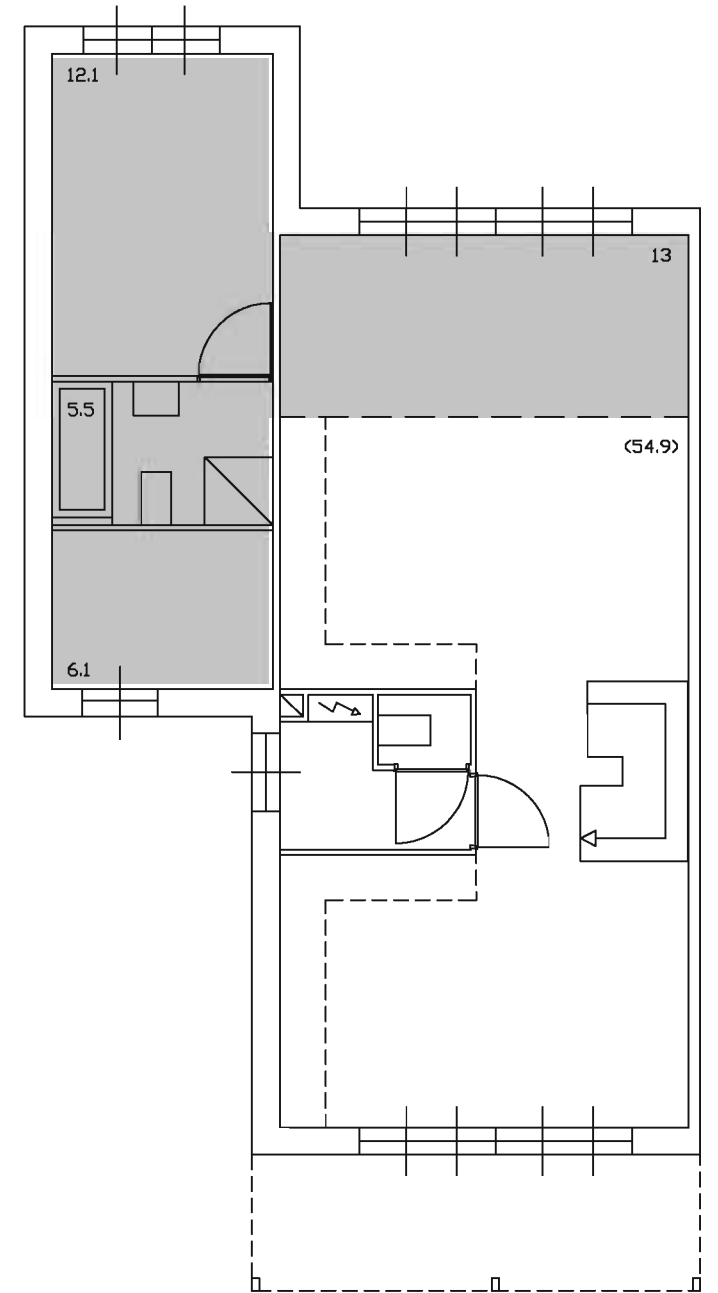

optie 13

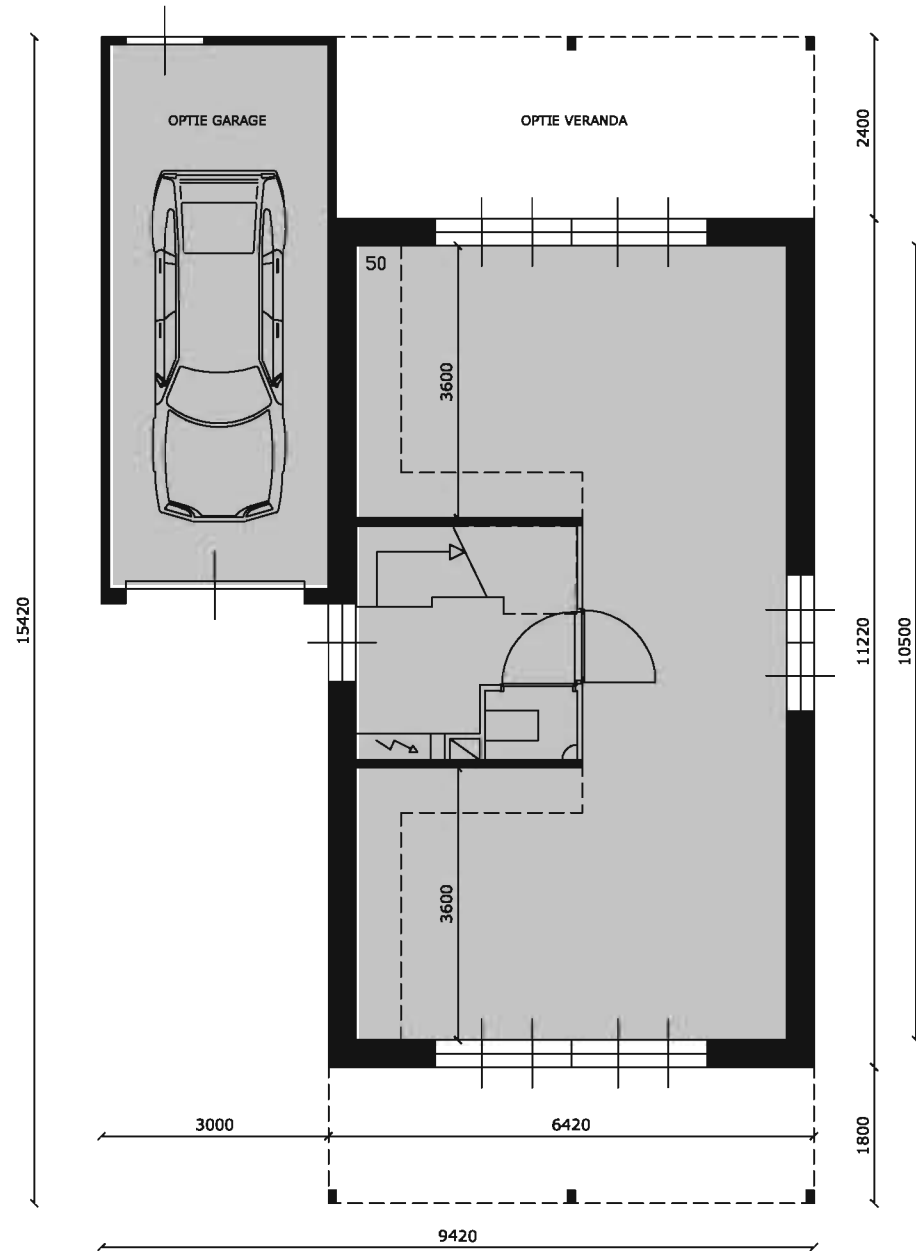

begane grond

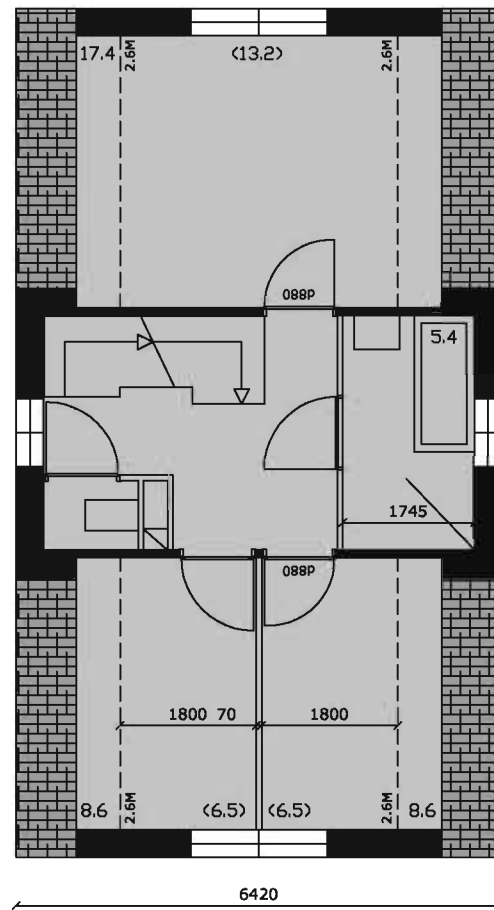

1e verdieping



2e verdieping

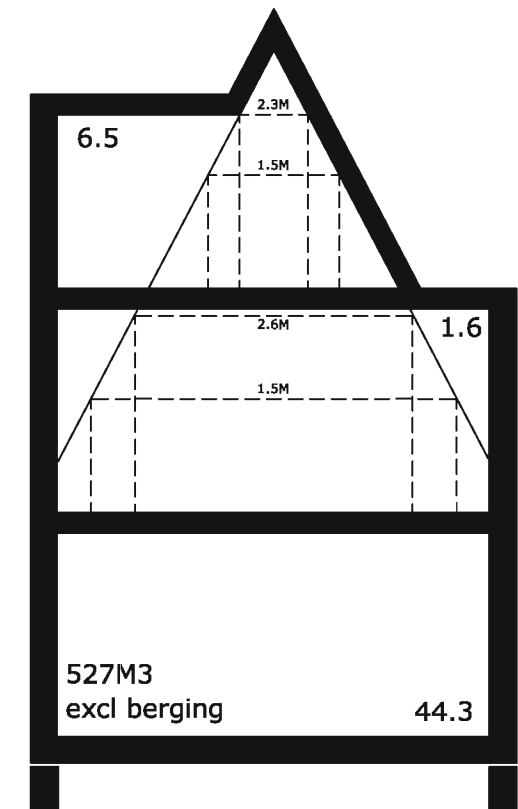

VRIJSTAANDE WONING



zijgevel



voorgevel



zijgevel



achtergevel

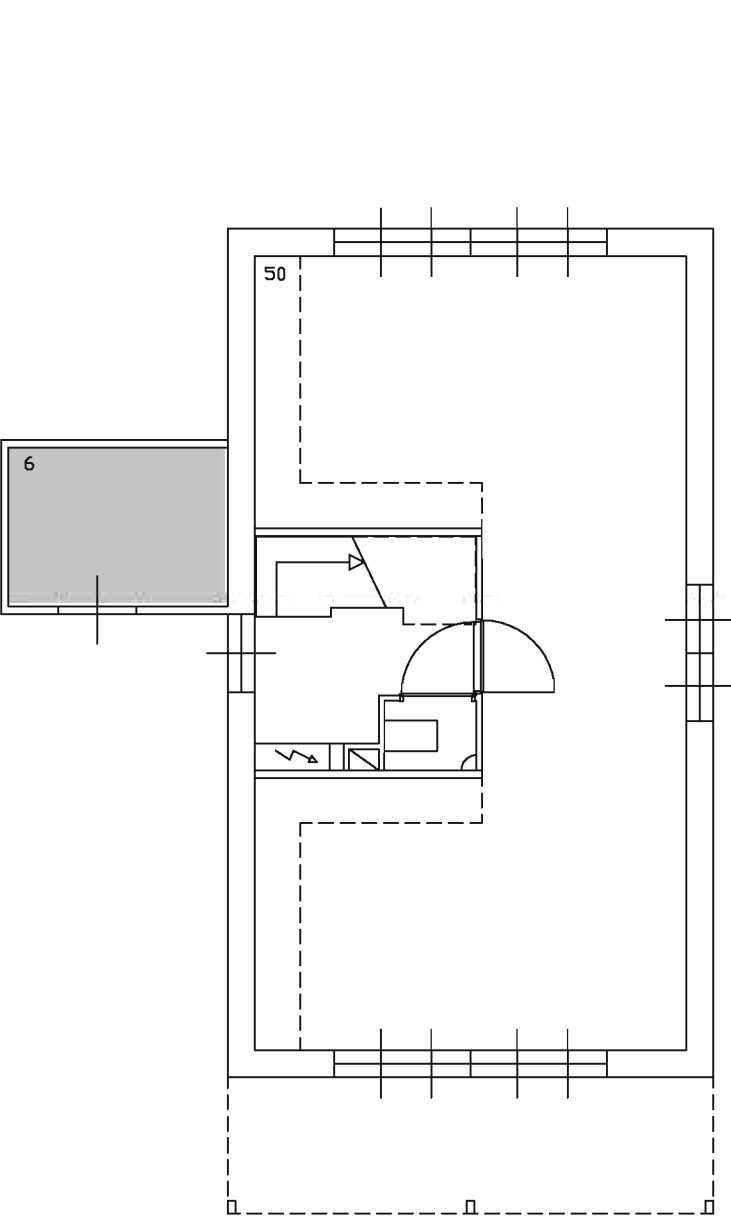

optie 1

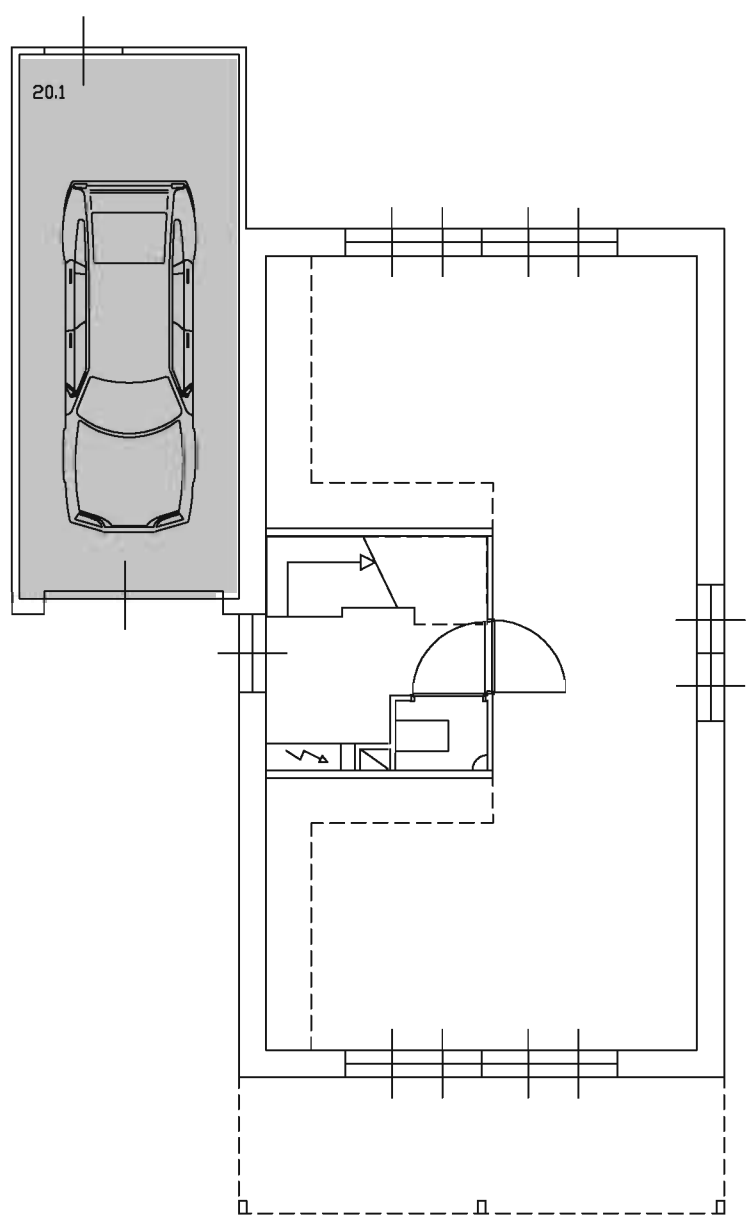

optie 2

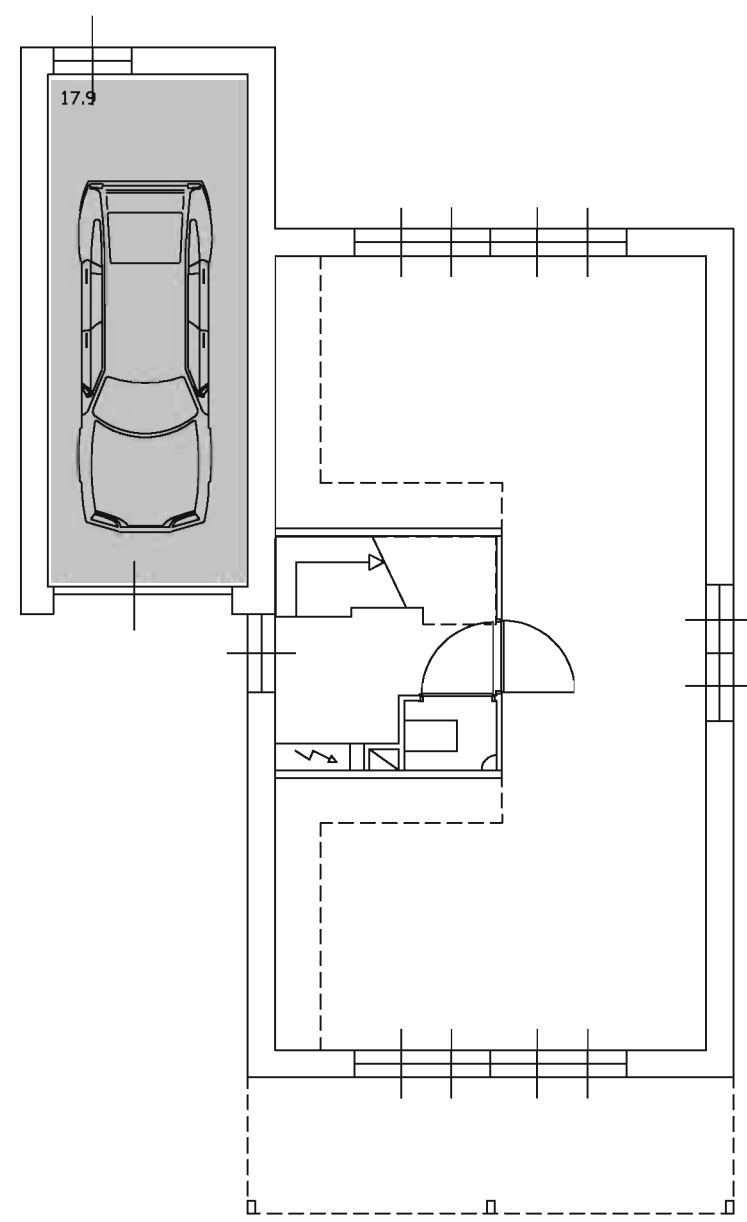

optie 3

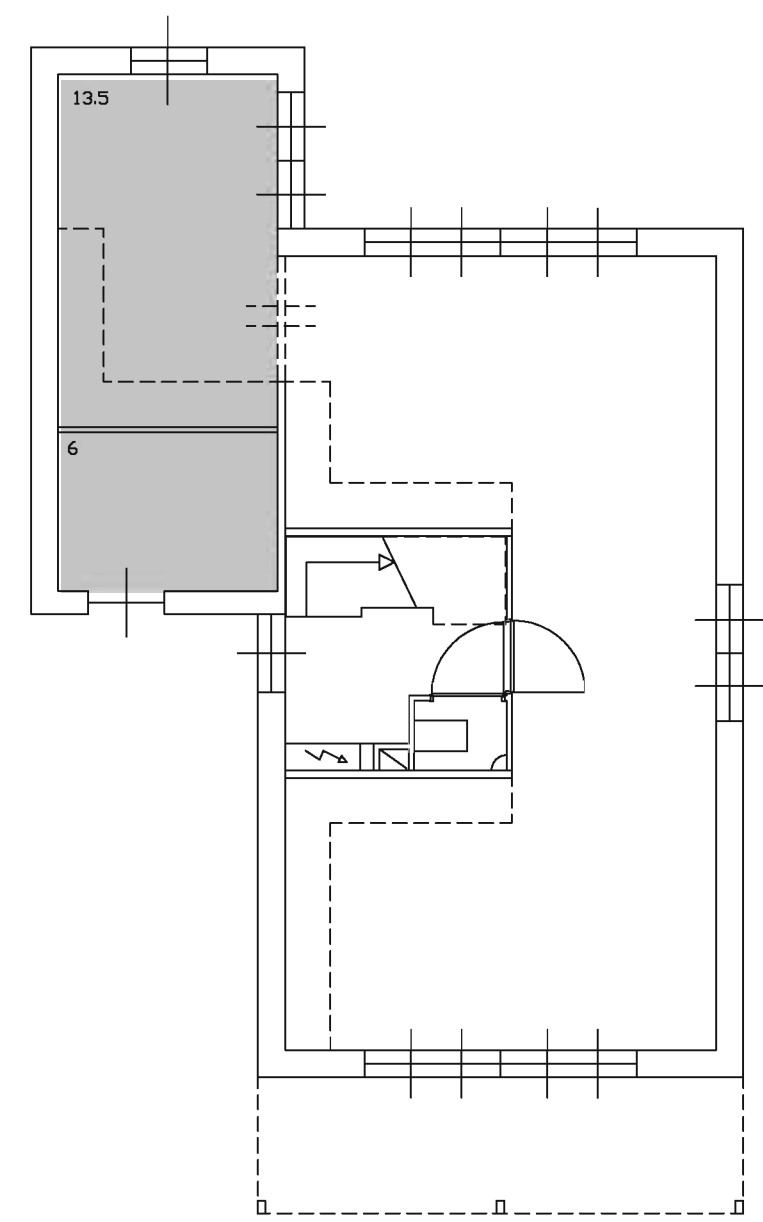

optie 4

opties
VRIJSTAANDE WONING

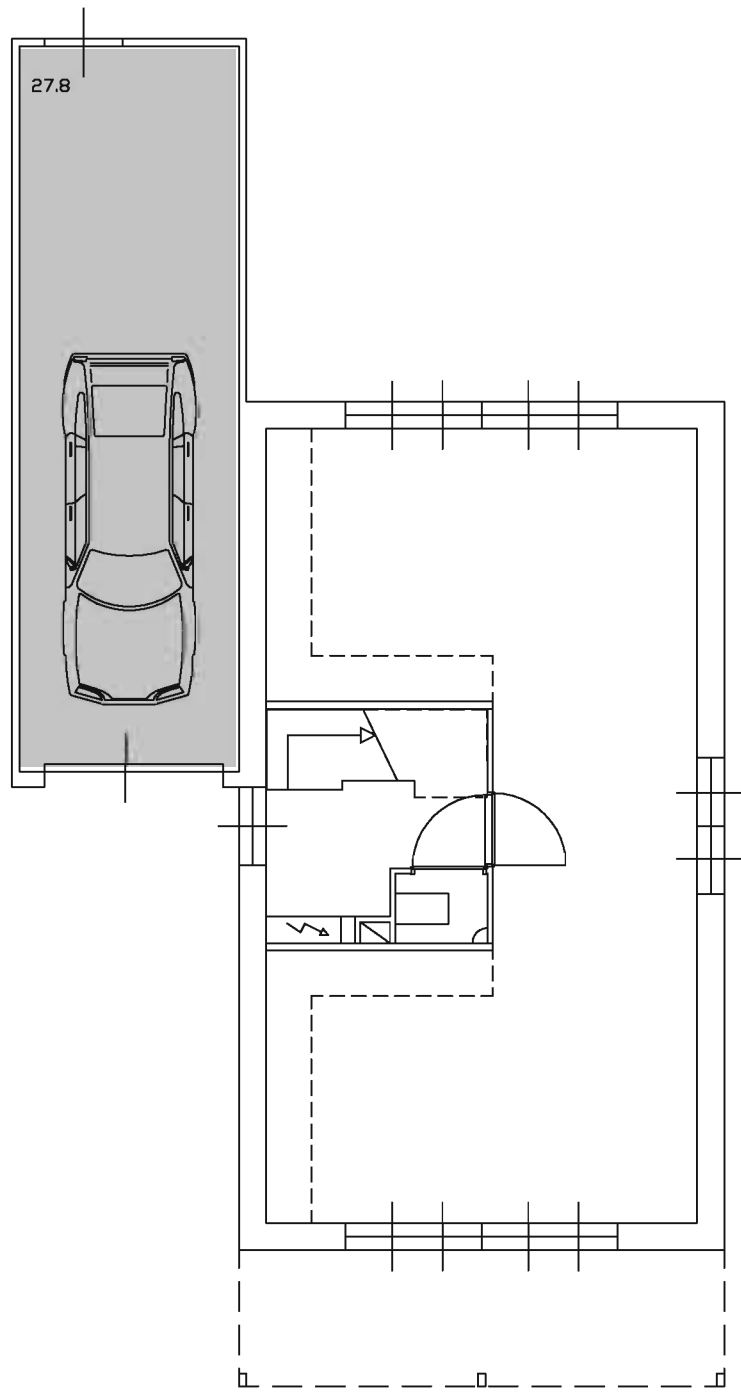

optie 5

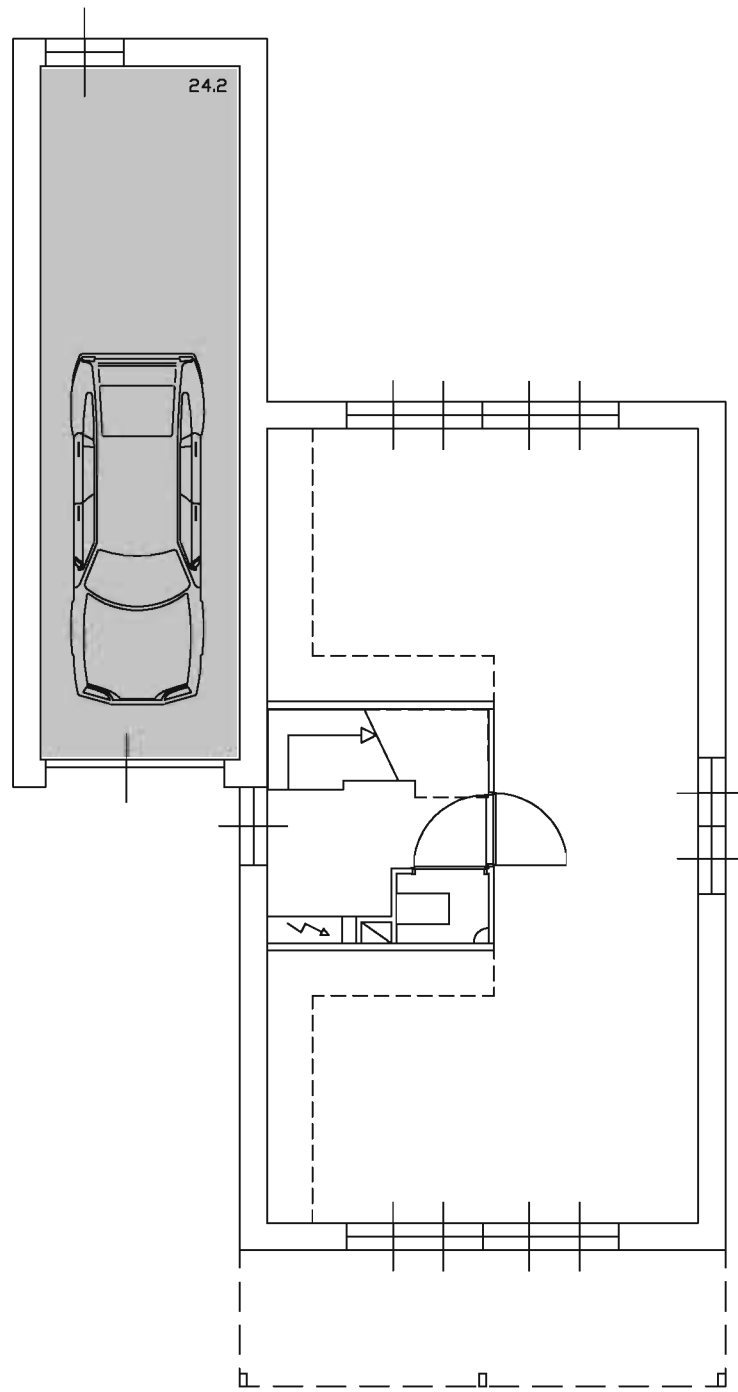

optie 6

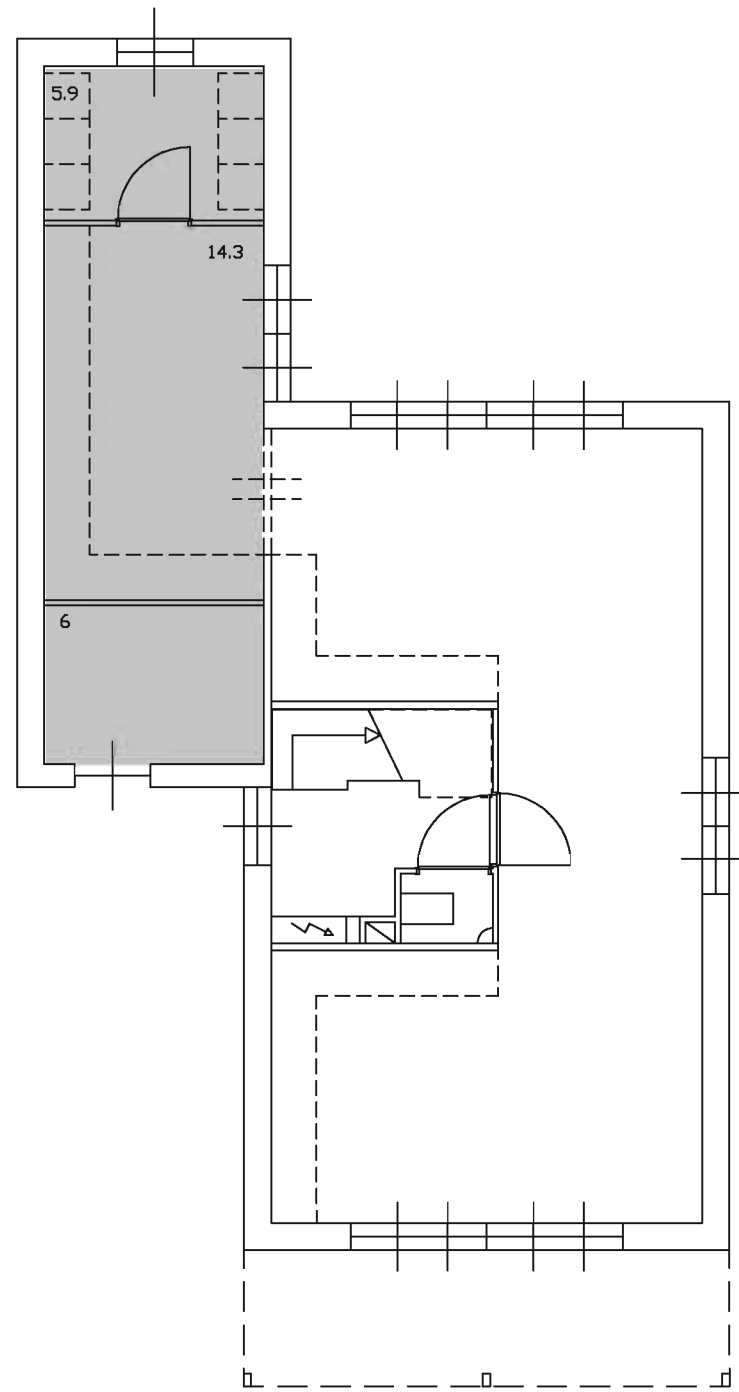

optie 7

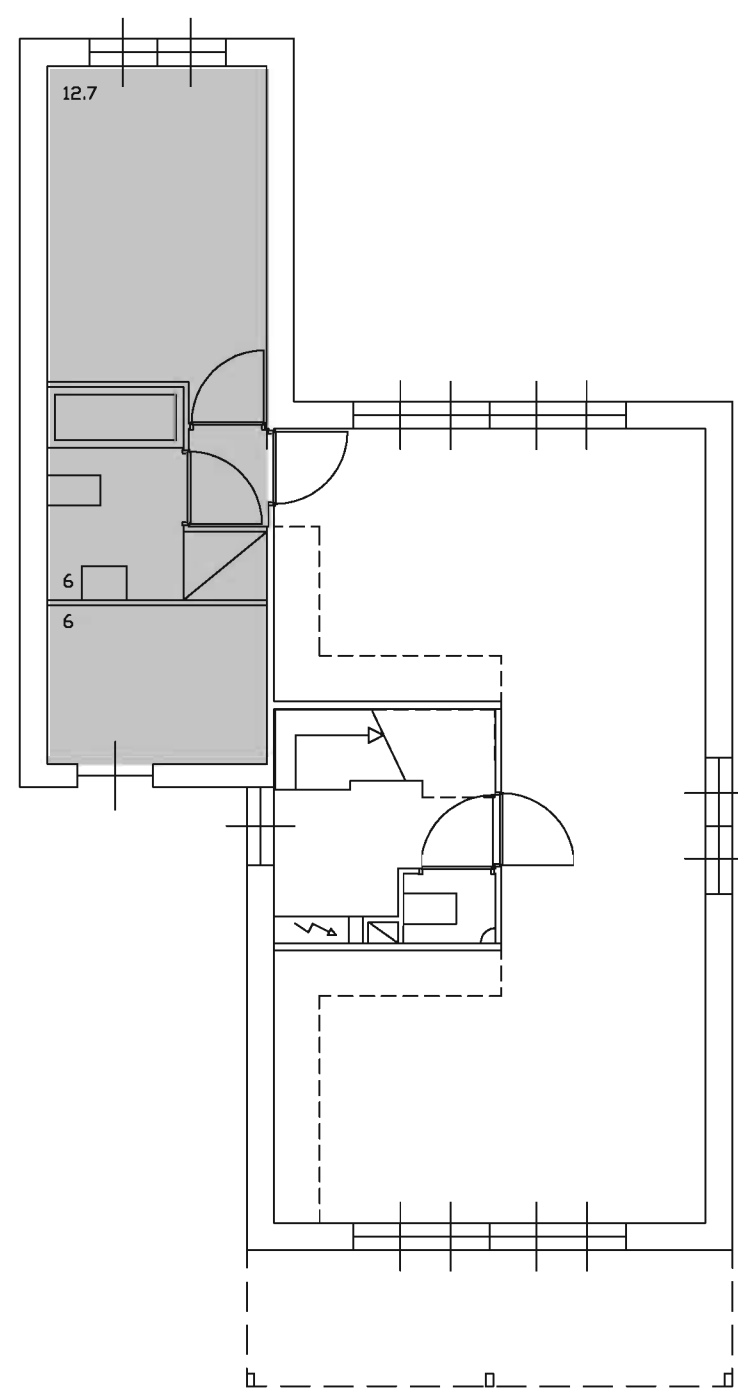

optie 8

opties
VRIJSTAANDE WONING

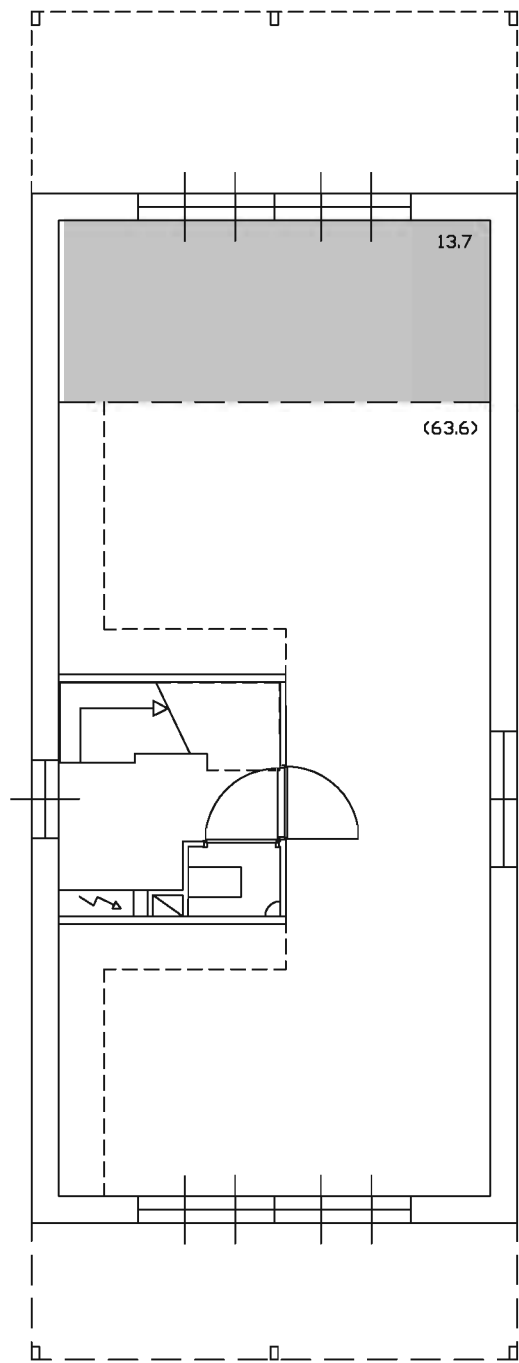

optie 9: uitbouw
optie 10: veranda

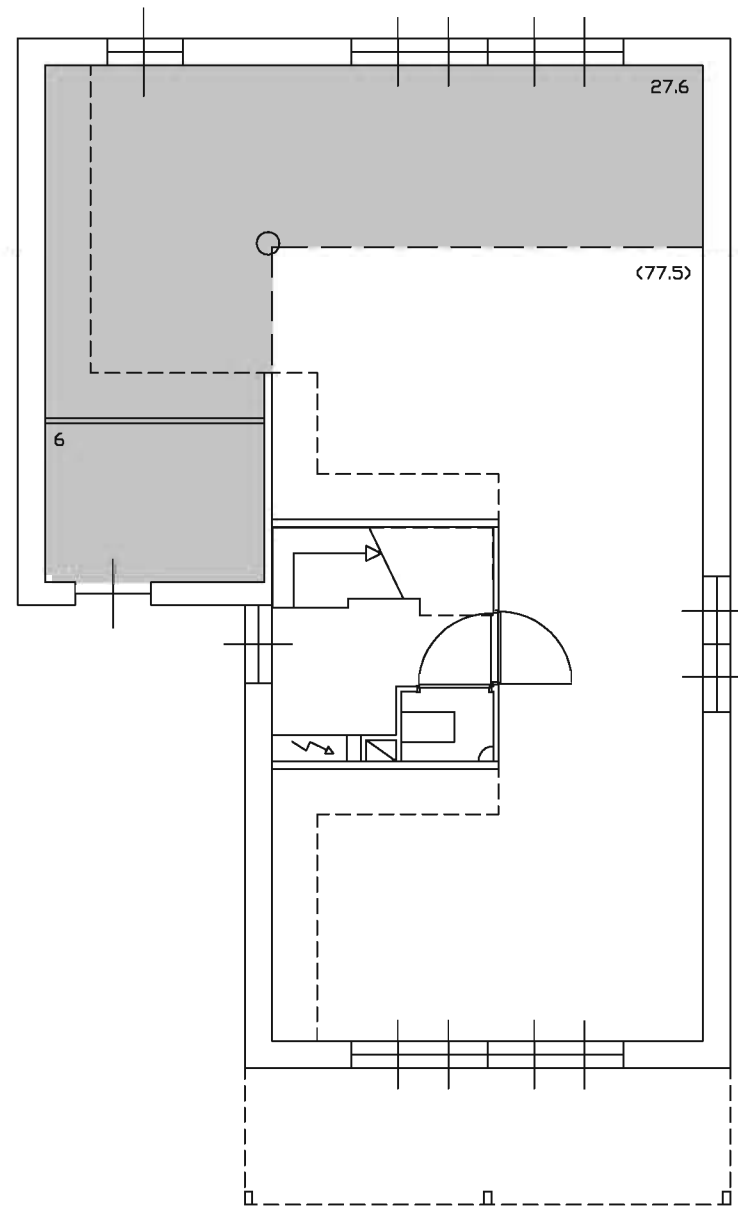

optie 11

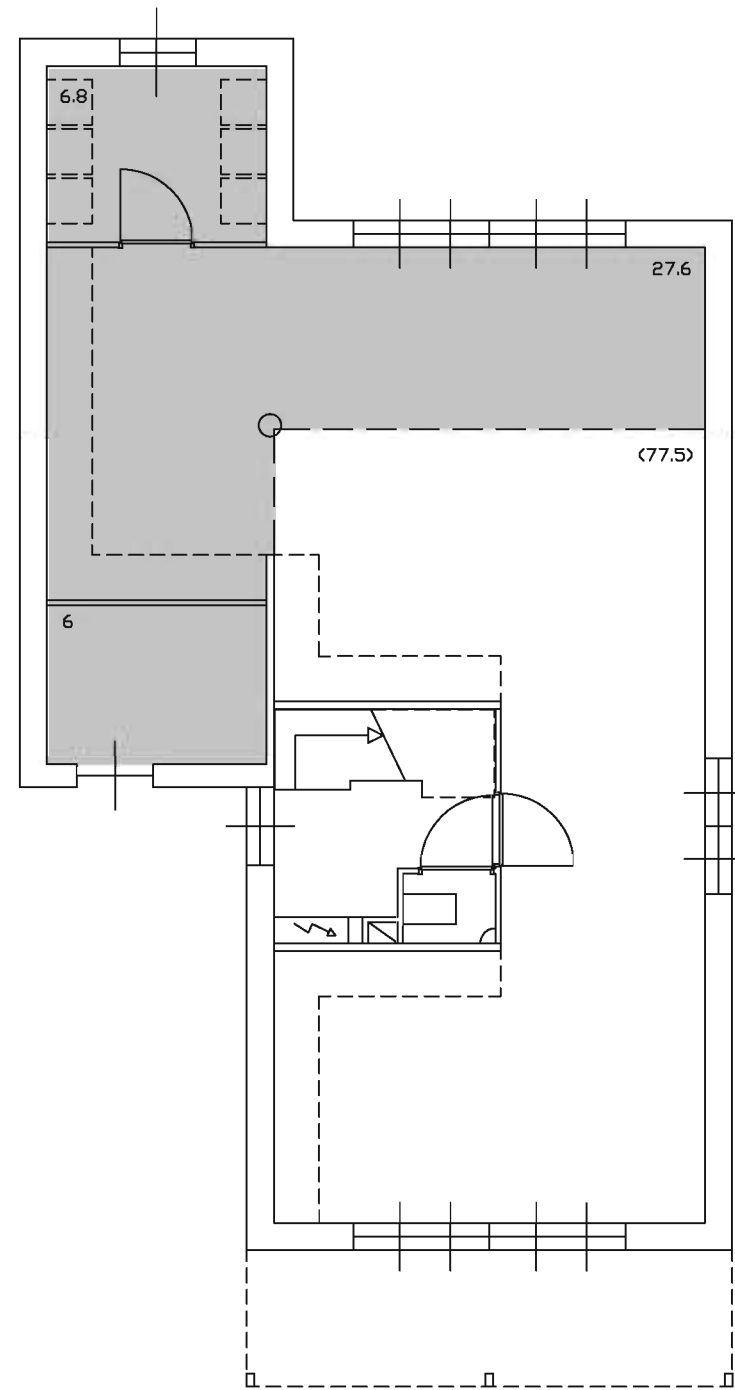

optie 12

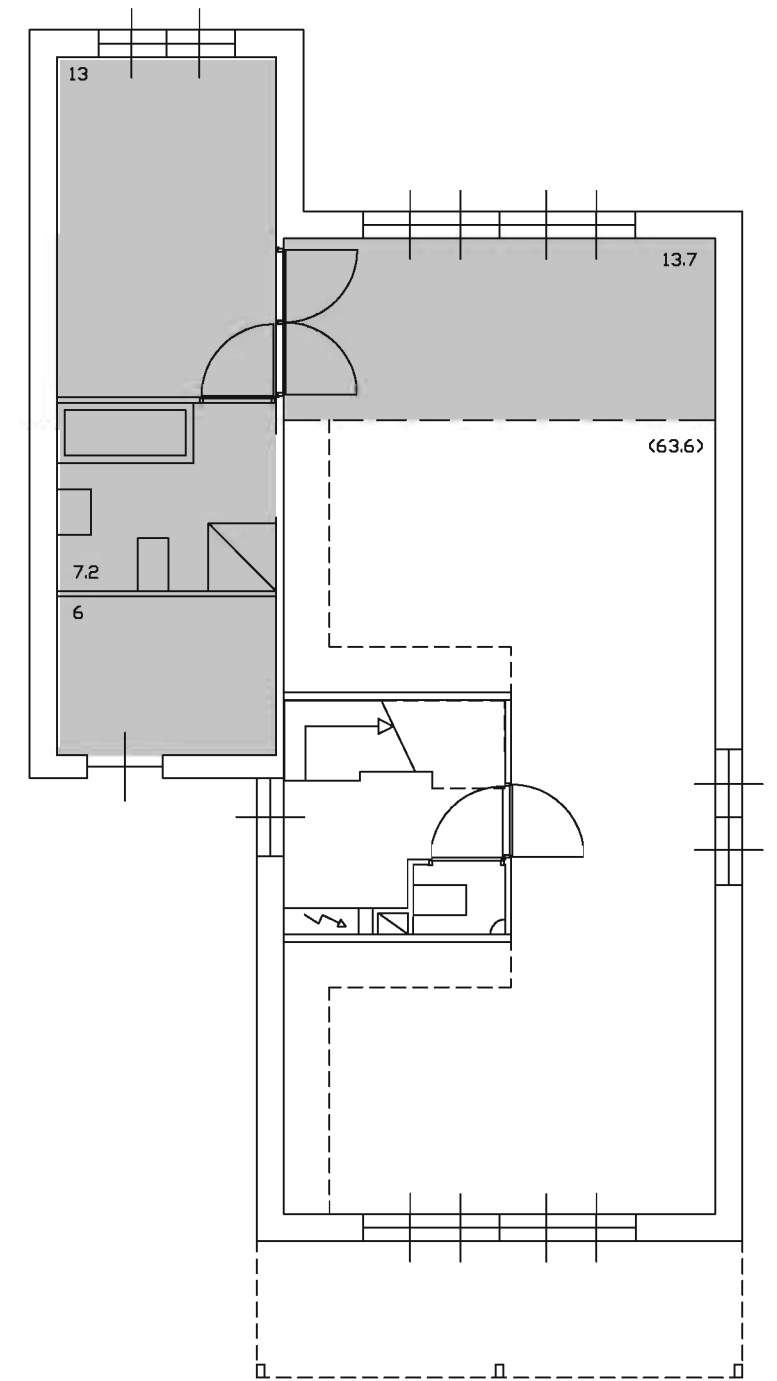

optie 13



dak: natuursteen leien

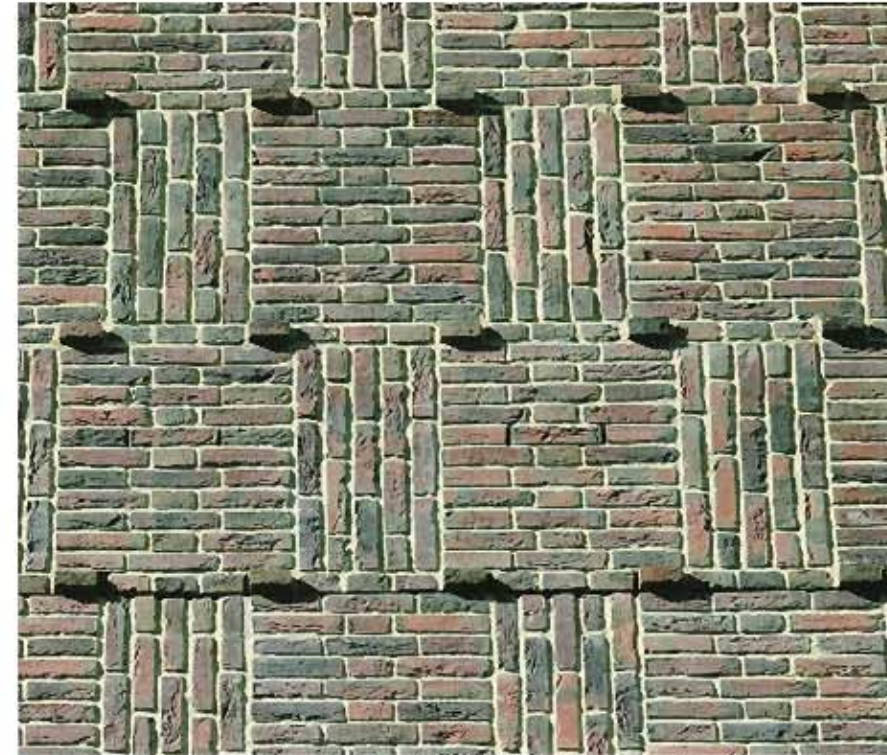

gevelvulling: metselwerk als vlechtwerk

